



Ruthanne Fuller
Mayor

City of Newton, Massachusetts
Department of Planning and Development
1000 Commonwealth Avenue Newton, Massachusetts 02459

#88-20
Telephone
(617) 796-1120
Telefax
(617) 796-1142
TDD/TTY
(617) 796-1089
www.newtonma.gov

Barney S. Heath
Director

MEMORANDUM

DATE: August 7, 2020

TO: Councilor Deborah Crossley, Chair, Zoning & Planning Committee
Members of the Zoning & Planning Committee

FROM: Barney Heath, Director, Department of Planning and Development
Zachery LeMel, Chief of Long Range Planning
Cat Kemmett, Planning Associate

RE: **#88-20 Discussion and review relative to the draft Zoning Ordinance**
DIRECTOR OF PLANNING requesting review, discussion, and direction relative to the draft Zoning Ordinance.
Other docket items to be taken up within the context of Zoning Redesign include #30-20, #38-20, and #148-20

MEETING: August 13, 2020

CC: City Council
Planning Board
John Lojek, Commissioner of Inspectional Services
Neill Cronin, Chief of Current Planning
Alissa O. Giuliani, City Solicitor
Jonathan Yeo, Chief Operating Officer

Reviewing Article 3 – Residence Districts To Date

Zoning & Planning Committee (ZAP)

The latest round of review of the draft Zoning Ordinance began this past March at ZAP. Highlights of the five months of work in Committee include reaffirming the goals and objectives, using detailed case studies to understand how the recommended mechanisms and standards function, and debating on how those recommended mechanisms and standards could be revised to more clearly and simply facilitate the evolution of Newton's residential neighborhoods according to those goals and objectives.

Of course, this latest round of work has taken place in truly unprecedented times. COVID-19 forced all ZAP meetings to move online and required city staff to think of new and creative ways of engaging to ensure that this process is transparent and accessible. Luckily, Committee meeting attendance has only increased since moving online. This is true not only for the public (with regular attendance of 50+ people), but also for non-ZAP City Councilors and the Planning & Development Board. ZAP Committee meetings, when discussing Zoning Redesign, averaged two-thirds of the City Council and the majority of the Planning & Development Board. City staff thank the City Councilors and Boards/Commission

members for their continued involvement and input, which have fully informed the revised Article 3 – Residence Districts draft zoning language shared here (Attachment A).

Additional Engagement & Outreach

In parallel with ZAP Committee meetings, the Planning Department quickly pivoted its engagement & outreach to online as well. Since March, the Planning Department has engaged over 100 residents through bi-weekly public office hours, held four architect and builder focus groups, and participated in numerous one-on-one conversations with various interested parties. Finally, we recently launched an updated Zoning Redesign website that provides all this most recent work, as well as Zoning Redesign work dating back nearly a decade, in a more user-friendly manner. Summaries, and in-depth materials, for all ZAP meeting and additional engagement & outreach events over the last five months can be found on the Current Drafting Status page:

http://www.newtonma.gov/gov/planning/lrplan/zoning_redesign/current/article_3.asp.

Guiding Goals and Objectives for Article 3 – Residence Districts Updates

As previously mentioned, comprehensive efforts on zoning reform (Zoning Redesign) began nearly a decade ago with the Zoning Reform Group (ZRG). From this beginning, the highest organizing principle for Zoning Redesign has been to align Newton’s Zoning Ordinance with the *Comprehensive Plan* (2007). Of course, Newton’s needs and challenges have evolved since 2007 and the City Council’s adopted plans and policy documents following the *Comprehensive Plan* reflect that. This past April the ZAP Committee unanimously reaffirmed the goals and objectives that have informed the revised draft recommendations for Article 3. The recommended mechanisms and standards should always be evaluated on if, and how well, they achieve these goals and objectives:

- Facilitate an increase and diversity of housing opportunities citywide
- Promote economic and environmental sustainability
- Ensure new development, and renovations, respect the physical character and scale of existing neighborhoods and align with adopted visions

Mechanisms and Standards to Achieve the Goals and Objectives

The mechanisms and standards within Article 3 – Residence Districts all work together to facilitate the incremental evolution of Newton’s neighborhoods consistent with these goals. The following list of mechanism and standards encompass the primary recommended updates within the latest draft. All changes can be found within Attachment A provided with this memo.

District Dimensional Standards & Allowed Building Types (Sec. 3.1)

The proposed five residence zoning districts (R1, R2, R3, R4 and N) are the foundation for regulation across Newton’s neighborhoods and roughly correspond to five of the existing residential districts (SR, SR2, SR3, MR1 and MR2). Taken all together, these district can be viewed as a transect that moves from larger lots/less building types (R1, R2, and R3) to smaller lots/more building types (R4 and N). This typically corresponds with Newton’s existing residential development patterns as areas further away from public transit and village centers to areas in much closer proximity to these resources respectively (see Fig 1).

The breakdown of dimensional standards (lot coverage, setbacks, etc.) and allowable building types (House A, Duplex, Small-Multi Use Building, etc.) within each proposed residential districts sets different, but appropriate, prioritization for achieving all the goals and objectives as follows:

Districts	Top Priority	Equal Priority	Priority
R1, R2, R3	Ensure new development, and renovations, respect the physical character and scale of existing neighborhoods and align with adopted visions	Promote economic and environmental sustainability	Facilitate an increase and diversity of housing opportunities
R4, N	Facilitate an increase and diversity of housing opportunities	Promote economic and environmental sustainability	Ensure new development, and renovations, respect the physical character and scale of existing neighborhoods and align with adopted visions

The recommendation of the different districts prioritizes the goals comes from two places. First, the City Council has regularly affirmed, most recently in the Climate Action Plan, that density should be situated near and around village centers and public transit. Second, urban planning and design best practice recommends focusing increased levels of development near areas of resources and amenities. This is often referred to as transit-oriented development (TOD) or [15-Minute Neighborhoods](#) where residents can generally take care of their everyday needs within a 15-minute walk of their homes.

Building Types (sec. 3.2)

Generally, the building types remain similar to what was proposed in the previous draft. However, working closely with Current Planning, ISD, and the architects/builders focus group the Planning Department is recommending changes to the dimensional standards for simpler and easier to use regulation. In particular, the building types no longer have minimum and maximum widths and depths. These numbers were not based on Newton’s existing buildings, as gathered from the Pattern Book. In addition, city staff believed these to be an example of overregulation because the building type footprint, lot coverage, setbacks, lot frontage, frontage buildout requirements, and standard construction practices all work together to ensure appropriate building proportions.

The simpler recommendation is that each building type be regulated by a maximum building footprint, number of stories, and story height. These simpler regulations also better take into consideration the diverse residential building forms across Newton. There are two exceptions, the Townhouse Section (sec. 3.2.9) and the Small Multi-Use Building (sec. 3.2.12), which have a maximum building width in addition to these simpler regulations. This is because the Townhouse Section must be developed as a series and having a maximum width ensure the sections are primarily oriented towards the street. For the Small Multi-Use Building, the maximum width prevents any development from having an overly long, undifferentiated street wall (See Fig. 2).

Another recommended change to the House A, B, and D building types can be found in the Additional Standards section for each type to further the City Council’s goals stated above. Specifically, the Planning Department recommends that new construction of these building types be allowed to have a maximum of two-units, as opposed to a single-unit. Existing House A, B, and D building types may convert into multiple units through the Multi-Unit Conversion (Sec. 3.5.2) regulation, which is discussed later in this memo.

This change would allow, it does not force or require, new construction of these building types to have two-units. Property owners have every right to build or renovate these building types as single-family homes. This would facilitate the advancement of more housing opportunity in building forms that respects the existing physical character and scale of existing neighborhoods because these building types are derived from the residential buildings that make up Newton today (see Fig 3). The table below shows how the maximum building footprints assigned to these building types corresponds to the median footprint size of Newton’s existing buildings:

Building Type	Existing Footprint (median)*	Recommended Footprint (maximum)
House A	2,407 sf	2,400 sf
House B	1,371 sf	1,400 sf
House D	2,314 sf	2,300 sf

***Based on data collected through the Pattern Book**

Because of this recommendation to allow two-units within the building types listed above, some building type names should be changed for clarity. The Planning Department recommends no change to the number of units allowed in these building types. These are:

Section	Building Type (March 2020)	Building Type (August 2020)
3.2.7	Two-Unit Residence	Duplex
3.2.8	3-Unit Building	Triple Decker
3.2.10	4-8 Unit Building	Small Apartment House

Lastly, for both simplicity and to better align building types with the visions set out in Newton’s various adopted plans, the Planning Department recommends the removal Small Shop (sec. 3.2.13) respectively. For the Small Shop, the Planning Department questions why the Zoning Ordinance would encourage new single-story commercial development? Though this form currently exists in Newton, it seems the goals of promoting economic sustainability and increasing housing opportunity warrants new development of this type to have ground floor commercial with residential or office above? Or allow existing buildings that match this form to have an opportunity to build an additional story for residential or office? If so, then this building form is captured in the Shop House (sec. 3.2.11) and is proposed only in the Neighborhood General District immediately adjacent to village centers.

Building Components (sec. 3.3)

Per discussions at ZAP, with city staff, and the architects/builders focus group, the Planning Department recommends updates to building components that allows existing homes to reasonably expand as homeowners needs change and for new development to expand beyond the maximum allowable footprint in a simpler, more predictable, manner. Building Components incorporate the innovative

thinking found in the Current Ordinance *De Minimus* regulation, data on Newton’s existing residential massing, and urban design best practice.

What does this mean? The Planning Department recommends that building components that can modestly increase footprint, Side Wing (sec. 3.3.2.F) and Rear Addition (sec. 3.3.2.G), on the smaller building types (House A – Duplex) be capped at 25% and for the larger building types (Townhouse Section – Small Multi-Use Building) be capped at 10% beyond the maximum building footprint. 25% for the smaller building types is based on data of existing housing stock, which allows a development with an appropriately sized lot to match the majority of existing structures of that building type. Adding such building components requires available lot coverage and space within the established setbacks, which helps ensure such increases are proportional and only occur on appropriately sized lots. Take House B as an example:

Building Type	Existing Conditions in Newton		Zoning Code Proposal		
	Existing Footprint (median)*	80 th Percentile of Existing House B Footprints	Recommended Footprint per Code (maximum)	25% Increase through Building Components	Building Footprint + Components (maximum)
House B	1,371 sf	1,723 sf	1,400 sf	350 sf*	1,750 sf

***Square footage here refers only to the footprint, not the overall square footage**

The above table shows that the draft zoning code allows, through building components for new development of a House Type B, or expansion of an existing one, to match in volume 80% of these similar homes in Newton. The Planning Department recommends the 80th percentile is appropriate because a Committee objective is to promote smaller homes as a part of more environmentally sustainable development patterns. The creation of the Side Wing (sec. 3.3.2.F) and Rear Addition (sec. 3.3.2.G) facilitates this and corresponds with the recommendation to remove the Special Permit allowance to increase the Building Type footprint size. The Planning Department recommends that building components offer a simpler by-right mechanism that offer a greater level of controlled flexibility and predictability than a Special Permit.

Alternative Lot/Building Configurations (sec. 3.5)

Alternative lot and building configurations acknowledge that Newton’s neighborhoods have a wide variety of lot shapes and sizes. Each mechanism allows for a different controlled approach to allowing development on these lots in-line with the City Council goals and objectives. The Planning Department recommends adding a purpose & intent statement to each mechanism that links to the goals and objectives. In addition, other key recommendations include:

- Multi-unit conversion (sec. 3.5.2)

Per our discussions at ZAP, a majority of the Committee, additional City Councilors in attendance, and Planning Board members voiced support for Multi-Unit Conversion as a mechanism to incentivize the preservation of Newton’s existing building stock and promoting an increase in diverse housing opportunities throughout the city. From this feedback, the Planning Department recommends expanding the allowed building types that can utilize this mechanism (sec. 3.5.2.A). Second, city staff recommend that Multi-Unit Conversions be allowed by-right if creating six residential units or less. To ensure

the exterior of the building is preserved, and generally limit abuse of this mechanism, additional language has been added from the current ordinance limiting exterior alterations (sec. 3.5.2.B).

- **Courtyard Cluster (sec. 3.5.3)**

Courtyard Cluster development is a building form that promotes community interaction through compact living clustered around a semi-private shared open space. The smaller than typical residential unit size is meant to provide a non-subsidized form of housing that is generally less expensive. Courtyard Clusters can also provide greater flexibility for families as their needs change over time and alternatives for seniors looking to downsize and remain in Newton. Given the intent of this development type, the Planning Department recommends limiting Courtyard Cluster developments to the R4 and N districts, which are proposed to be adjacent to amenities and resources found in village centers and public transit hubs.

Additional recommended changes

All changes, including the ones mentioned above, can be found within Attachment A provided with this memo. In addition, all the changes to Article 3 made between the draft shared in March 2020 and the latest draft shared here are documented in a changelog (Attachment B). Finally, a draft User's Guide to Article 3 – Residence Districts is provided here (Attachment C). The User's Guide is meant to outline how a property owner would go about using Article 3 to determine what they can and cannot do on their property, and call out the specific sections within Article 3 where more information can be found. Having the User's Guide is also meant to graphically visualize what is possible within each given Residence District. The next iteration of Article 3 will contain detailed graphics and tables that do this directly within the zoning document.

Meeting Objectives and Outcomes

The Planning Department hopes to use the August 13 ZAP meeting to illustrate how the proposed recommendation to Article 3 – Residence Districts better, and more closely, reflect the goals and objectives set forward by the Committee and City Council. To date, the Planning Department has focused on setting the correct mechanisms and standards, the actual zoning language, which will be presented at this meeting. The Planning Department hopes the Committee can come to a consensus on the following general items:

- That the proposed districts, and allowed building types within each district, facilitate future development that aligns with stated goals and objectives. This can be summarized as:
 - Larger lots with less building types, are appropriate for areas further away from village centers and public transit (Districts: R1, R2, and R3)
 - Smaller lots with more building types, are appropriate for areas closer to village centers and public transit (Districts: R4 and N)
- Allowing the option of two-units within the House A, House B, and House D building types ensures that the opportunity for more diverse housing is equitably distributed citywide and appropriately respects existing neighborhood contexts

- Special Permit allowances or requirements have been revised to apply to the forms of development that constitute greater levels of review and are recommended to be removed in instances that simplify and streamline the permitting process (a general Zoning Redesign objective) or would limit the ability to achieve the stated goals and objectives (ex. allowing certain multi-unit conversion by-right)

Looking Ahead

Coming to a general consensus on the proposed Residence Districts mechanisms and standards, and that they generally achieve the Committee/Council goals and objectives, will set up the Committee to discuss the Residence Districts map at the following meeting, on August 31. The Planning Department plans on presenting two data-based map frameworks that build from the 2018 draft zoning map, while more directly responding to the latest goals and objects affirmed in Committee.

Attachments

Attachment A Article 3 – Residence Districts, revised draft

Attachment B Article 3 – Residence Districts, change log

Attachment C User’s Guide to Residence Zoning in Newton, draft

Figure 1: Newton's Residential Districts and Existing Patterns

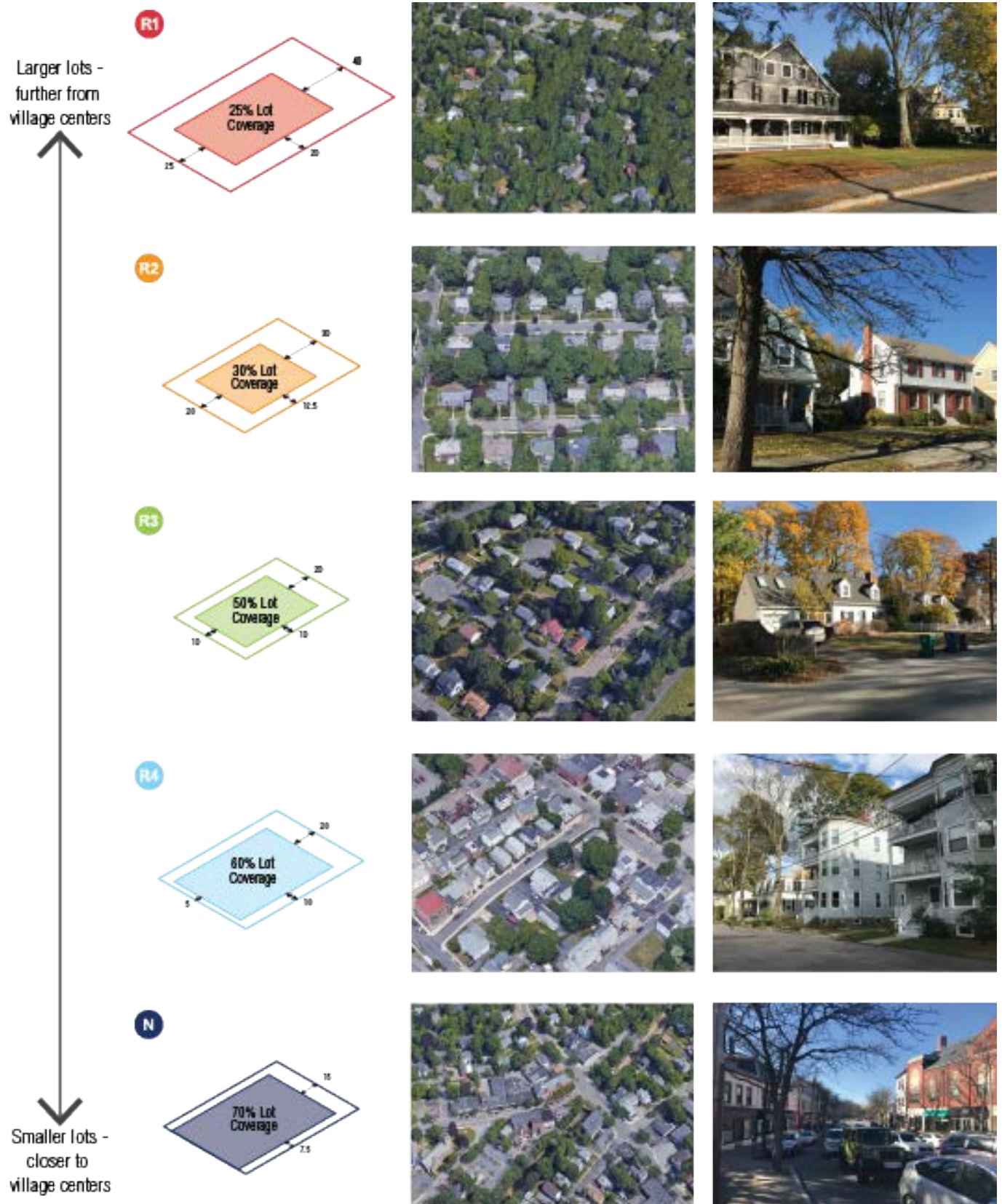
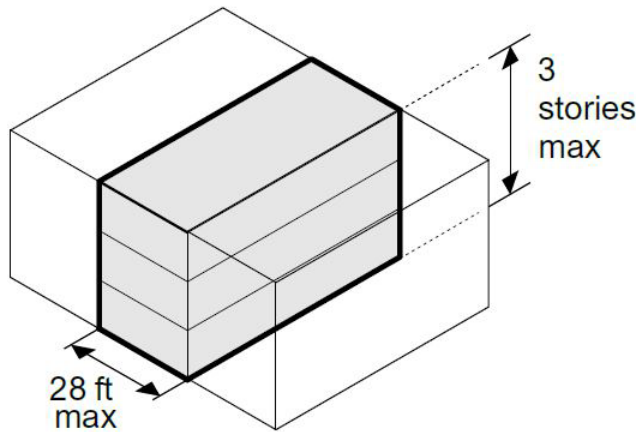
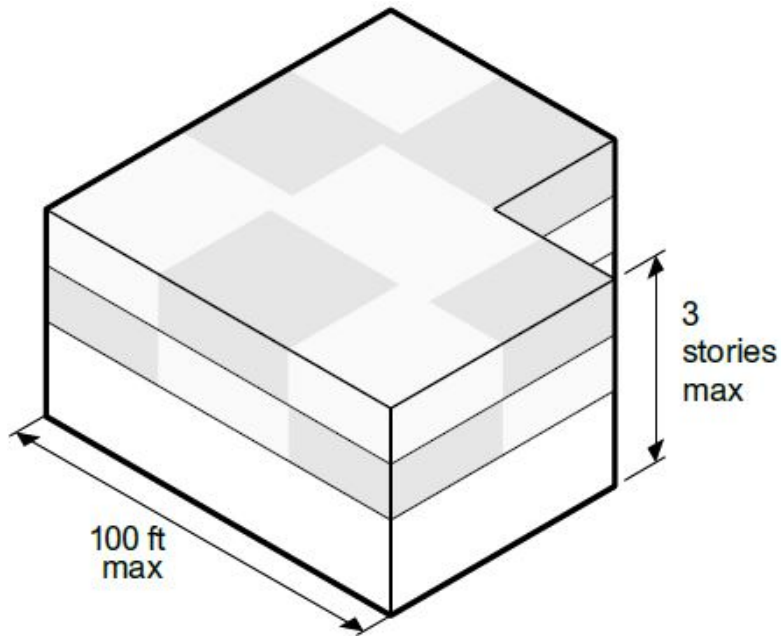

Figure 2: Maximum Width Requirements for Townhouse Sections and Small-Multi-Use Buildings



Townhouse Section

max footprint 1500 sf



Small Multi-Use Building

max footprint 12000 sf

Figure 3: Two-family Development that Respect and Do Not Respect Neighborhood Character



Two-family home in Newton Highlands (closely matches House Type B)



Recently built two-family home in Newton Corner (does not match any House Type)

Article 3 Residence Districts

3.1. Residence Districts

The provisions of Article 3 apply to all real property within the Residence Districts as shown on the Newton Zoning Map.

Commented [ZL1]: Revised zoning map recommendations the Residential Districts will be shared prior to August 31, 2020 ZAP Meeting

3.1.1. Development Review.

Development on any lot, by right or by discretionary permit, requires the submittal of development review materials to the specified development review body as required in Article 11.

- A. A pre-submittal discussion or meeting with the Planning Department and/or Inspectional Services Department is recommended for all development (See Sec. 11.2.2).
- B. Proposed development may or may not necessitate Site Plan Approval, a Special Permit or a Variance based on the nature of the proposal. In such cases, additional development review is required in accordance with Article 11.
- C. Upon completion of the required development review or verification that no additional development review is necessary, the ~~Commissioner of ISD shall issue a Zoning Consistency Determination indicating compliance with the provisions and procedures of this Ordinance-issuance of a building permit by ISD indicates compliance with the provisions and procedures of this ordinance.~~
- D. The Special Permit Granting Authority is determined by the thresholds listed in the table below, or by the uses on the lot (See Article 9).

[Reserved]

Commented [ZL2]: The Planning Department recommends that the discussion on who is the Special Permit Granting Authority, and at what scale of project, to happen when taking up Article 11 – Administration.

3.1.2. Residence 1 District (R1)

A. Context Description.

The Residence 1 District is composed of neighborhoods characterized typically by larger homes on larger parcels of land. These neighborhoods consist almost entirely of single-unit residences with significant areas of landscaping and trees. Where other uses exist or may be proposed, the City would like to preserve the existing building stock by allowing for existing buildings to be renovated or converted to multiple dwelling units or to a civic institution.

B. Purpose.

1. To permit the development of detached residential buildings on individual lots in scale and context with these neighborhoods throughout the City.
2. To permit contextual modifications of existing detached residential buildings in a predictable manner for homeowners and neighbors.
3. To create a mechanism for the preservation and continued use of existing building stock architecturally-significant homes by allowing for existing buildings to be renovated or converted to multiple dwelling units or to a civic institution.
4. To promote, through building and lot design, community connections.

C. Dimensional Standards.

The following table contains lot standards for the Residence 1 District:

Lot Characteristics	
Frontage:	Min. 80 ft, Max. -
Lot Depth:	N/A
Lot Coverage:	25% Max; +10% by SP (See Sec. 2.3.2)

The following table contains setback standards for the Residence 1 District:

Setbacks	Min	Max
Front:	25 ft	-
Side:	20 ft	-
Rear:	40 ft	-
Frontage Buildout	-	-

D. Building Types.

1. The following principal building types are permitted in the Residence 1 District:
 - a. House A (Sec. 3.2.3)
 - b. House B (Sec. 3.2.4)
 - c. House C (Sec. 3.2.5)
 - d. House D (Sec. 3.2.6)
 - ~~e. Civic Building (Sec. 3.2.14)~~

E. Alternate Lot/Building Configurations.

1. The following alternate lot/building configurations are permitted by Special Permit in the Residence 1 District:
 - a. Rear Lots (Sec. 3.5.1)
2. Multi-Unit Conversions (Sec. 3.5.2) are permitted in the Residence 1 District. Depending on the scale of the project, a Special Permit may be required.

- ~~f. Multi-Unit Conversion (Sec. 3.5.2)~~
- ~~g. Courtyard Clusters (Sec. 3.5.3)~~

F. Allowed Uses.

Uses permitted in the Residence 1 District are described in Sec. 3.6 and subject to further regulations as described in each building type.

3.1.3. Residence 2 District (R2)

A. Context Description.

The Residence 2 District contains quintessentially suburban neighborhoods with ample lawns and mostly single-unit residences, developed primarily in the 20th Century in areas between Newton’s villages. Many of these neighborhoods are remote from the walkable village centers of the City and therefore do not have nearby gathering places, shops, or services.

B. Purpose.

1. To permit the development of detached residential buildings on individual lots in scale and context with these neighborhoods throughout the City.
2. To permit contextual modifications of existing detached residential buildings in a predictable manner for homeowners and neighbors.
3. To create a mechanism for the preservation and continued use of existing building stock architecturally significant homes by allowing for existing buildings to be renovated or converted to multiple dwelling units or ~~to~~ a civic institution.
4. In limited circumstances, to retain or allow neighborhood serving commercial uses in order to enhance walkability and sustainability.
5. To promote, through building and lot design, community connections.

C. Dimensional Standards.

The following table contains lot standards for the Residence 2 District:

Lot Characteristics	
Frontage:	60 ft Min, 110 ft Max
Lot Depth:	-
Lot Coverage:	30% Max; +10% by SP (See Sec. 2.3.2)

The following table contains setback standards for the Residence 2 District:

Setbacks	Min	Max
Front:	<u>Contextual Front Setback (See Sec. 3.4.1A)</u> Absolute Min: 20 ft	40 ft
Side:	12.5 ft	-
Rear:	30 ft	-
Frontage Buildout	<u>Minimum greater</u> of 12 ft or 25% of the <u>lot frontage, whichever is greater</u> ; non-conforming lots exceeding the max. frontage have a min. of 27.5 ft	-

D. Building Types.

1. The following principal building types are permitted in the Residence 2 District:
 - a. House B (Sec. 3.2.4)
 - b. House C (Sec. 3.2.5)
 - ~~c. Civic Building (Sec. 3.2.14)~~
2. The following principal building types are permitted, subject to a Special Permit, in the Residence 2 District:
 - a. House D (3.2.6)

- b. **Review Criteria.** In its discretion to approve or deny a special permit authorizing construction of a new House D, the Special Permit Granting Authority must find that the application meets the following criteria:
 - i. The criteria for all Special Permits specified in Sec. 11.4.3.
 - ii. Design and landscaping is compatible with the neighborhood and adjacent properties.
 - iii. The site and building as designed, constructed, and operated will contribute significantly to the efficient use and conservation of natural resources and energy.

E. **Alternate Lot/Building Configurations.**

- 1. The following alternate lot/building configurations are permitted by Special Permit in the Residence 2 District:
 - a. Rear Lots (Sec. 3.5.1)
 - 2. Multi-Unit Conversions (Sec. 3.5.2) are permitted in the Residence 2 District. Depending on the scale the project, a Special Permit may be required.
 - ~~b. Courtyard Clusters (Sec. 3.5.3)~~

F. **Allowed Uses.**

Uses permitted in the Residence 2 District are described in Sec. 3.6 and subject to further regulations as described in each building type.

3.1.4. Residence 3 District (R3)

A. Context Description.

The Residence 3 District includes neighborhoods composed of single, two, and three-unit homes, frequently within walking distance to transit and activity centers. The intent of this district is to increase predictability for homeowners in how they may modify their homes and integrate appropriately scaled new homes into the fabric of the neighborhoods that make up this district.

B. Purpose.

1. To permit the development of detached residential buildings on individual lots in scale and context with these neighborhoods throughout the City.
2. To permit contextual modifications of existing detached residential buildings in a predictable manner for homeowners and neighbors.
3. To create a mechanism for the preservation and continued use of existing building stock architecturally significant homes by allowing for existing buildings to be renovated or converted to multiple dwelling units ~~or to~~ a civic institution.
4. In limited circumstances, to retain or allow neighborhood serving commercial uses in order to enhance walkability and sustainability.
5. To promote, through building and lot design, community connections.

C. Dimensional Standards.

The following table contains lot standards for the Residence 3 District:

Lot Characteristics	
Frontage:	50 ft Min, 100 ft Max
Lot Depth:	-
Lot Coverage:	50% Max; +10% by SP (See Sec. 2.3.2)

The following table contains setback standards for the Residence 3 District:

Setbacks	Min	Max
Front:	Contextual Front Setback (See Sec. 3.4.1A) Absolute Min: 10 ft	35 ft
Side:	10 ft	-
Rear:	20 ft	-
Frontage Buildout	Minimum greater of 12 ft or 25% of the <u>lot</u> frontage, <u>whichever is greater</u> ; non-conforming lots exceeding the max. frontage have a min. of 25 ft	

D. Building Types.

1. The following principal building types are permitted in the Residence 3 District:
 - a. House B (Sec. 3.2.4)
 - b. House C (Sec. 3.2.5)
 - c. Duplex Two-Unit Residence (Sec. 3.2.7)
 - ~~d. Civic Building (Sec. 3.2.14)~~
2. The following principal building types are permitted, subject to a Special Permit, in the Residence 3 District:

- a. ~~Triple Decker 3-Unit Building~~ (Sec. 3.2.8)
- b. **Review Criteria.** In its discretion to approve or deny a special permit authorizing ~~construction of a new Triple-Decker 3-Unit Building~~, the Special Permit Granting Authority must find that the application meets the following criteria:
 - i. The criteria for all Special Permits specified in Sec. 11.4.3.
 - ii. Design and management strategies achieve compatibility with the neighborhood and adjacent residential properties.
 - iii. ~~Off-street parking available provides an adequate supply of parking (drawing guidance from existing standards in the Newton Zoning Ordinance) while also minimizing the presence of large parking areas and extensive areas of pavement.~~

E. Alternate Lot/Building Configurations.

- 1. The following alternate lot/building configurations are permitted by Special Permit in the Residence 3 District:
 - a. Rear Lots (Sec. 3.5.1)
 - 2. Multi-Unit Conversions (Sec. 3.5.2) are permitted in the Residence 3 District. Depending on the scale of the project, a Special Permit may be required.
 - b. ~~Courtyard Clusters (Sec. 3.5.3)~~

F. Allowed Uses.

Uses permitted in the Residence 3 District are described in Sec. 3.6 and subject to further regulations as described in each building type.

3.1.5. Residence 4 District (R4)

A. Context Description.

The Residence 4 District includes neighborhoods composed mostly of multi-unit buildings, with single-unit residences as well, frequently within walking distance to transit and activity centers.

B. Purpose.

1. To allow for multiple forms of development that create greater housing choices and opportunities that provides a transition between Residence 1, 2, and 3 Districts and the Neighborhood General Districts and Village Districts.
2. To permit contextual modifications of existing detached residential buildings in a predictable manner for homeowners and neighbors.
3. To create a mechanism for the preservation and continued use of existing building stock architecturally-significant homes by allowing for existing buildings to be renovated or converted to multiple dwelling units or ~~to~~ a civic institution.
4. In limited circumstances, to retain or allow neighborhood serving commercial uses in order to enhance walkability and sustainability.
5. To promote, through building and lot design, community connections.

C. Dimensional Standards.

The following table contains lot standards for the Residence 4 District:

Lot Characteristics	
Frontage:	50.40ft Min, 100 ft Max
Lot Depth:	-
Lot Coverage:	60% Max; +10% by SP (See Sec. 2.3.2)

The following table contains setback standards for the Residence 4 District:

Setbacks	Min	Max
Front:	Contextual Front Setback (See Sec. 3.4.1A) Absolute Min: 5 ft	35 ft
Side:	107.5 ft	-
Rear:	2015 ft	-
Frontage Buildout	Minimum greater of 12 ft or 25% of the lot frontage, <u>whichever is greater</u> ; non-conforming lots exceeding the max. frontage have a min. of 25 ft	

D. Building Types.

1. The following principal building types are permitted in the Residence 4 District:
 - a. House B (Sec. 3.2.4)
 - b. House C (Sec. 3.2.5)
 - c. Duplex Two-Unit Residence (Sec. 3.2.7)
 - d. Triple Decker 3-Unit Building (Sec. 3.2.8)
 - e. ~~Civic Building (Sec. 3.2.14)~~
2. The following principal building types are permitted, subject to a Special Permit, in the Residence 4 District:

- a. ~~4-8 Unit Building~~ Small Apartment House (Sec. 3.2.10)
- b. Review Criteria. In its discretion to approve or deny a special permit authorizing a new Small Apartment House ~~4-8 Unit Building~~, the Special Permit Granting Authority must find that the application meets the following criteria:
 - i. The criteria for all Special Permits specified in Sec. 11.4.3.
 - ii. Design and management strategies achieve compatibility with the neighborhood and adjacent residential properties.
 - iii. ~~Off-street parking available provides an adequate supply of parking (drawing guidance from existing standards in the Newton Zoning Ordinance) while also minimizing the presence of large parking areas and extensive areas of pavement.~~
 - iv. ~~iii.~~ Preservation and/or enhancement of landscaped areas and trees, especially to serve as a buffer to neighboring lots.

E. Alternate Lot/Building Configurations.

- 1. The following alternate lot/building configurations are permitted by Special Permit in the Residence 4 District:
 - a. Rear Lots (Sec. 3.5.1)
 - b. Courtyard Clusters (Sec. 3.5.3)
- 2. Multi-Unit Conversions (Sec. 3.5.2) and Multi-Building Assemblages (Sec. 3.5.4) are permitted in the Residence 4 District. Depending on the scale of the project, a Special Permit may be required.
- 3. ~~Multi-Unit Conversion (Sec. 3.5.2)~~
- e. ~~Courtyard Clusters (Sec. 3.5.3)~~
- 4. ~~Multi-Building Assemblage (Sec. 3.5.4)~~

F. Allowed Uses.

Uses permitted in the Residence 4 District are described in Sec. 3.6 and subject to further regulations as described in each building type.

3.1.6. Neighborhood General District (N)

A. Context Description.

Within a short walk of the amenities, mixture of uses, and transit options found in Newton’s village centers, the Neighborhood General District serves as a transition from the village centers to the adjoining neighborhoods. With easy access to the above amenities, these areas are appropriate for a wider range of housing types, including small multi-unit residential buildings and townhouses, as well as a range of small-scale neighborhood-serving commercial spaces.

B. Purpose.

1. To allow for multiple forms of development that create greater housing choices and opportunities that balance the scale of the adjacent residential neighborhoods and village centers.
2. To permit the development of detached residential buildings on individual lots.
3. To permit townhome-style buildings.
4. To permit contextual modifications of existing detached residential buildings in a predictable manner for homeowners and neighbors.
5. To retain or allow neighborhood serving commercial uses in order to enhance walkability and sustainability.
6. To create a mechanism for the preservation and continued use of existing building stock architecturally-significant homes by allowing for existing buildings to be renovated or converted to multiple dwelling units or ~~to~~ a civic institution.
7. To promote, through building and lot design, community connections.

C. Dimensional Standards.

The following table contains lot standards for the Neighborhood General District:

Lot Characteristics	
Frontage:	4030 ft Min, 100 ft Max
Lot Depth:	-
Lot Coverage:	70% Max; +10% by SP (See Sec. 2.3.2)

The following table contains setback standards for the Neighborhood General District:

Setbacks	Min	Max
Front:	Contextual Front Setback (See Sec. 3.4.1A) Absolute Min: 0 ft	25 ft
Side:	7.5 ft	-
Rear:	15 ft	-
Frontage Buildout	Minimum greater of 12 ft or 40% of the lot frontage, whichever is greater; nonconforming lots exceeding the max. frontage have a min. of 40 ft	

D. Building Types.

1. The following principal building types are permitted in the Neighborhood General District:
 - a. House B (Sec. 3.2.4)

- b. House C (Sec. 3.2.5)
 - c. ~~Duplex~~Two-unit residence (Sec. 3.2.7)
 - d. ~~Triple Decker~~3-Unit Building (Sec. 3.2.8)
 - e. Townhouse Section (Sec. 3.2.9)
 - f. ~~Small Apartment House~~4-8 Unit Building (Sec. 3.2.10)
 - g. Shop House (Sec. 3.2.11)
 - ~~h. Small Shop (Sec. 3.2.13)~~
 - ~~i. Civic Building (Sec. 3.2.14)~~
2. The following principal building types are permitted, subject to a Special Permit, in the Neighborhood General District:
- a. Small Multi-Use Building (Sec. 3.2.12)
- E. Alternate Lot/Building Configurations.
1. The following alternate lot/building configurations are permitted by Special Permit in the Neighborhood General District:
- a. Rear Lots (Sec. 3.5.1)
 - ~~b. Multi-Unit Conversion (Sec. 3.5.2)~~
 - ~~e-b.~~ Courtyard Clusters (Sec. 3.5.3)
2. ~~A Multi-Unit Conversions (Sec. 3.5.2) and~~ Multi-Building Assemblages (Sec. 3.5.4) ~~are~~ permitted in the Neighborhood General District. Depending on the scale of the project, a Special Permit may be required.
- F. Review Criteria. In its discretion to approve or deny a special permit authorizing a new small multi-use building or a multi-building assemblage, the Special Permit Granting Authority must find that the application meets the following criteria:
- 1. The criteria for all Special Permits specified in Sec. 11.4.3.
 - 2. Design and management strategies achieve compatibility with the neighborhood and adjacent residential properties.
 - 3. Transportation management and design strategies intend to reduce reliance on single-occupant automobiles.
 - ~~4. On and off-street parking available provides an adequate supply of parking (drawing guidance from existing standards in the Newton Zoning Ordinance) while also minimizing the presence of large parking areas and extensive areas of pavement.~~
 - ~~5-4.~~ Preservation and/or enhancement of landscaped areas and trees, especially to serve as a buffer to neighboring lots.
- G. Allowed Uses.
- Uses permitted in buildings in the Neighborhood General District are described in Sec. 3.6 and subject to further regulations as described in each building type.

3.2. Building Types.

3.2.1. Introduction to Building Types.

This Ordinance uses building types as a tool to regulate development within each zoning district.

- A. Building types are a way of organizing standards for the size, shape, and scale of principal buildings. Standards should be read in conjunction with Article 2, which includes rules of measurement.
- B. Building type standards apply to all principal buildings, whether new construction, renovation or addition to an existing structure, and redevelopment.
- C. In contrast to applying generic dimensional standards to all principal structures, the use of Building Types as a regulatory tool allows dimensional standards to differ from one class or kind of structure to another within the same district.
- D. The selection of building types permitted within a zoning district combine with the mix of permitted uses to define the intended character of each zoning district.

~~3.2.2. Special Permit to Vary the Dimensional Standards of a Building Type.~~

~~A Special Permit may be granted to vary the dimensions of a building type within the standards specified and in accordance with Sec. 11.4.~~

~~A. Review Criteria. In its discretion to approve or deny a special permit authorizing a variation in the dimensional standards of a building type, the Special Permit Granting Authority must find that the application meets the following criteria:~~

- ~~1. The criteria for all Special Permits specified in Sec. 11.4.3.~~
- ~~2. Design strategies achieve compatibility with the scale of neighboring properties.~~
- ~~3. Design strategies break up the massing and modulate the roof line.~~

3.2.2. Building Assembly

- A. Building Types are comprised of the Main Massing of a building and various additional Building Components.
- B. The Main Massing is the primary and the most important portion defining a Building Type's form and scale. The Main Massing of each Building Type is regulated using building dimensional standards that differ for each type.
- C. Building Components are accessory features attached to the main massing of a Principal Building, or other Building Components to create assemblies of components. Building Components increase the habitable square footage or enhance the usefulness of a building. Each Building Component has dimensional standards that differ for each type.
- A-D. Building Components provide an important means for achieving variety and individuality in design and are permitted as indicated for each Building Type.

3.2.3. House A

A. Description.

A house with a large footprint and up to 2.5 stories. House A building types are common in several Newton neighborhoods like Chestnut Hill, Waban, and West Newton Hill. House A types may have been built in several eras of Newton’s development history from the era when Newton was a destination for country estates to the modern development period of the 1980s to the present.

B. Building Dimensional Standards.

Building Width		Building Depth	Building Footprint	Number of Stories	Story Heights
Min	Max	Max	Max	Max	All Stories
25 ft	100 ft	100 ft	2,400 sf	2.5 stories	Max 12 ft SP: 14 ft

SP – Special Permit with mandatory design review (See Sec. 3.2.2)

C. Fenestration on the Front Elevation.

1. Ground Story Fenestration: 20% Minimum, 70% Maximum
2. Upper Story Fenestration: 10% Minimum, 70% Maximum

D. Roof Types.

All Roof Types are permitted.

E. Additional Standards.

1. Only residential use categories are permitted; option for use conversion of an existing building according to Sec. 3.6.1.B.
2. Maximum of (1 or 2) Residential Unit; option for Multi-unit conversion according to Sec. 3.5.2.
3. The following Building Components may be used to increase the maximum Building Footprint by no more than 25 percent:
 - a. Side Wing (Sec. 3.3.2.F)
 - b. Rear Addition (Sec. 3.3.2.G)

Commented [ZL3]: Allowing two-units within these residential House Types can help achieve the City Council goals of increasing housing opportunity (citywide) in a form that matches and responds the existing residential building forms within Newton’s neighborhoods.

3.2.4. House B

A. Description.

A house with a medium footprint and up to 2.5 stories. House B building types can be found throughout Newton. The House B type includes typical midscale Victorian homes close to village centers, and midscale Colonial homes frequently built in the era of suburban infill between Newton’s historic village centers.

B. Building Dimensional Standards.

Building Width		Building Depth	Building Footprint	Number of Stories	Story Heights
Min	Max	Max	Max	Max	All Stories
15 ft	65 ft	90 ft	1,400 sf	2.5 stories	Max 12 ft SP: 14 ft

SP = Special Permit with mandatory Design Review (See Sec. 3.2.2)

C. Fenestration on the Front Elevation.

1. Ground Story Fenestration: 20% Minimum, 70% Maximum
2. Upper Story Fenestration: 10% Minimum, 70% Maximum

D. Roof Types.

All Roof Types are permitted.

E. Additional Standards.

1. Only residential use categories are permitted; option for use conversion of an existing building according to Sec. 3.6.1.B.
2. Maximum of [(1 or 2)] Residential Unit; option for Multi-unit conversion according to sec. 3.5.2.
3. The following Building Components may be used to increase the maximum Building Footprint by no more than 25 percent:
 - a. Side Wing (Sec. 3.3.2.F)
 - e.b. Rear Addition (Sec. 3.3.2.G)

Commented [ZL4]: Allowing two-units within these residential House Types can help achieve the City Council goals of increasing housing opportunity (citywide) in a form that matches and responds the existing residential building forms within Newton’s neighborhoods.

3.2.5. House C

A. Description.

A house with a small footprint and up to 1.5 stories. House C building types are located across Newton and are most typified by the bungalow or cape house style. House C building types are most likely to have been built between the 1920s when the bungalow style gained popularity through the post-war construction boom of the 1950s.

B. Building Dimensional Standards.

Building Width		Building Depth	Building Footprint	Number of Stories	Story Heights
Min	Max	Max	Max	Max	All Stories
12 ft	65 ft	80 ft	1,200 sf	1.5 stories	Max 12 ft SP: 14 ft

SP = Special Permit with mandatory Design Review (See Sec. 3.2.2)

C. Fenestration on the Front Elevation.

1. Ground Story Fenestration: 20% Minimum, 70% Maximum

D. Roof Types.

All Roof Types with an equivalent of 0 or 0.5 stories are permitted.

E. Additional Standards.

1. Only residential use categories are permitted; option for use conversion of an existing building according to Sec. 3.6.1.B.
2. Maximum of 1 Residential Unit; option for Multi-unit conversion according to sec. 3.5.2.
3. The following Building Components may be used to increase the maximum Building Footprint by no more than 25 percent:
 - a. Side Wing (Sec. 3.3.2.F)
 - b. Rear Addition (Sec. 3.3.2.G)

3.2.6. House D

A. Description.

A house with a large footprint and no more than 1 story. House D building types are best known as Ranch houses – and are characterized by 1-floor living with or without a basement. The House D building type is most common in southern Newton and is typical of mid-20th century development.

B. Building Dimensional Standards.

Building Width		Building Depth	Building Footprint	Number of Stories	Story Heights
Min	Max	Max	Max	Max	Ground Story
30 ft	120 ft	100 ft	2,300-500 sf	1 story	Max 12 ft SP: 14 ft

SP = Special Permit with mandatory Design Review (See Sec. 3.2.2)

C. Fenestration on the Front Elevation.

1. Ground Story Fenestration: 20% Minimum, 70% Maximum

D. Roof Types.

All Roof Types with an equivalent of 0 stories are permitted.

E. Additional Standards.

1. Only residential use categories are permitted; option for use conversion of an existing building according to Sec. 3.6.1.B.
2. Maximum of (1 or 2) Residential Unit; option for Multi-unit conversion according to sec. 3.5.2.
3. The following Building Components may be used to increase the maximum Building Footprint by no more than 25 percent:
 - a. Side Wing (Sec. 3.3.2.F)
 - b. Rear Addition (Sec. 3.3.2.G)

Commented [ZL5]: Allowing two-units within these residential House Types can help achieve the City Council goals of increasing housing opportunity (citywide) in a form that matches and responds the existing residential building forms within Newton's neighborhoods.

3.2.7. Duplex Two-Unit Residence

A. Description.

The two-unit residence Duplex building type is common in Newton's traditional mill village areas like the Upper Falls and Nonantum, as well as in early commuter neighborhoods near transit like West Newton, Newtonville and Auburndale. Two-unit residence Duplex building types are can be organized with one unit above and one below, two units side-by-side, or the second floor is split between the two units a combination as in the case of a "Philadelphia-style" duplex.

B. Building Dimensional Standards.

Building Width		Building Depth	Building Footprint	Number of Stories	Story Heights
Min	Max	Max	Max	Max	All Stories
20 ft	65 ft	80 ft	1,800-2,000 sf	2.5 stories	Max 12 ft SP: 14 ft

SP = Special Permit with mandatory Design Review (See Sec. 3.2.2)

C. Fenestration on the Front Elevation.

1. Ground Story Fenestration: 20% Minimum, 70% Maximum
2. Upper Story Fenestration 10% Minimum, 70% Maximum

D. Roof Types.

All roof types are permitted.

E. Additional Standards.

1. Only residential use categories are permitted; option for use conversion of an existing building according to Sec. 3.6.1.B.
2. Must have 2 Residential Units, one on the first floor and one on the second floor. Alternatively, may have 2 Residential Units with the first unit comprised of the first floor and a portion of the second floor, and the second unit comprised of the remainder of the second floor.
3. The following Building Components may be used to increase the maximum Building Footprint by no more than 25 percent:
 - a. Side Wing (Sec. 3.3.2.F)
 - b. Rear Addition (Sec. 3.3.2.G)

3.2.8. Triple Decker 3-Unit Building

A. Description.

A small multi-unit residential building containing 3 units, vertically stacked no more, no less. The scale of a Triple Decker 3-Unit Building is similar to 1- and 2-unit building types nearby, just with a few smaller than average units. Triple Decker building types Apartment houses were commonly built during the industrial revolution, and include the triple-decker, a building type unique to New England communities.

B. Building Dimensional Standards.

Building Width		Building Depth	Building Footprint	Number of Stories	Story Heights
Min	Max	Max	Max	Max	All Stories
20 ft	65 ft	80 ft	1,800+600 sf	3 stories	Max 12 ft SP: 14 ft

SP = Special Permit with mandatory Design Review (See Sec. 3.2.2)

C. Fenestration on the Front Elevation.

1. Ground Story Fenestration: 20% Minimum, 70% Maximum
2. Upper Story Fenestration: 10% Minimum, 70% Maximum

D. Roof Types.

All Roof Types are permitted.

E. Additional Standards.

1. Only residential use categories are permitted; option for use conversion of an existing building according to Sec. 3.6.1.B.
2. Must have 3 residential units, stacked one over the other.
3. The following Building Components may be used to increase the maximum Building Footprint by no more than 10 percent:
 - a. Side Wing (Sec. 3.3.2.F)
 - b. Rear Addition (Sec. 3.3.2.G)

3.2.9. Townhouse Section

A. Description.

A series of connected one- to two-unit houses, called townhouse sections, with separate entrances. The townhouse section building type first are seen in Newton in the late -18th century, but most townhouses in Newton date from the late 20th and early 21st century. Traditional townhouses come up to the street with alley access from the rear. Assemblages of 3 or 4 townhouse sections are found in neighborhoods across Newton. Large townhouse complexes are more typically found in southern Newton.

B. Building Dimensional Standards.

The following standards apply to each townhouse section.

Building Width		Building Depth	Building Footprint	Number of Stories	Story Heights
Min	Max	Max	Max	Max	All Stories
14 ft	28 ft	-	1,500 sf	3 stories	Max 12 ft SP: 14 ft

SP = Special Permit with mandatory Design Review (See Sec. 3.2.2)

C. Fenestration on the Front Elevation.

The following standards apply to each townhouse section:

1. Ground Story Fenestration: 20% Minimum, 70% Maximum
2. Upper Story Fenestration: 10% Minimum, 70% Maximum

D. Roof Types.

All Roof Types are permitted.

E. Additional Standards.

1. Only residential use categories are permitted; option for use conversion of an existing building according to Sec. 3.6.1.B.
2. Maximum of 2 Residential Units are permitted per townhouse section.
3. In no case may an attached series of townhouses contain less than 2 townhouse sections or more than 8 townhouse sections.
4. At least 2+ 1 townhouse Sectionunit in a series must be oriented toward the primary front lot line.
5. The following Building Components may be used to increase the maximum Building Footprint by no more than 10 percent:
 - a. Side Wing (Sec. 3.3.2.F)
 - b. Rear Addition (Sec. 3.3.2.G)

3.2.10. ~~4-8 Unit Building~~ Small Apartment House

A. Description.

A Small Apartment House is small multi-unit residential building. Whether built as a stand-alone building or as part of a complex, small apartment buildings typically are no taller than the peak of the roof of houses ~~and apartment houses~~ in the surrounding neighborhood and ~~approximately~~ about the footprint of two ~~mid-large attached house~~ Duplex or Triple-Decker building types.

B. Building Dimensional Standards.

Building Width		Building Depth	Building Footprint	Number of Stories	Story Heights
Min	Max	Max	Max	Max	All Stories
20 ft	75 ft	80 ft	3,600 2,500 sf	3 stories	Max 12 ft SP: 14 ft

~~SP = Special Permit with mandatory Design Review (See Sec. 3.2.2)~~

C. Fenestration on the Front Elevation.

1. Ground Story Fenestration: 20% Minimum, 70% Maximum
2. Upper Story Fenestration: 10% Minimum, 70% Maximum

D. Roof Types.

All Roof Types are permitted.

E. Additional Standards.

1. Only residential use categories are permitted; option for use conversion of an existing building according to Sec. 3.6.1.B.
2. Must have between 4 and 8 residential units.
3. Outdoor Amenity Space (Sec. 2.9): 1/dwelling unit, may be shared.
4. The following Building Components may be used to increase the maximum Building Footprint by no more than 10 percent:
 - a. Side Wing (Sec. 3.3.2.F)
 - b. Rear Addition (Sec. 3.3.2.G)

3.2.11. Shop House

A. Description.

A small mixed-use building, typically a house with a ground floor shopfront containing a commercial use. Shop houses typically start as house or townhouse section building types with a shopfront added to the front elevation. Shop houses are commonly found at the edges of Newton’s traditional village centers and can contain a variety of uses. Often shop houses are grouped together as multi-building assemblages.

B. Building Dimensional Standards.

Building Width		Building Depth	Building Footprint	Number of Stories	Story Heights	
Min	Max	Max	Max	Max	Ground Story	Upper Stories
20 ft	40 ft	80 ft	2,000 sf	2.5 stories	Max 20 ft	Max 12 ft SP: 14 ft

SP = Special Permit with mandatory Design Review (See Sec. 3.2.2)

C. Fenestration on the Front Elevation.

1. Ground Story Fenestration: 40% Minimum
2. Upper Story Fenestration: 10% Minimum, 70% Maximum
3. Max Blank Wall = 20 ft x 20 ft

D. Roof Types.

All Roof Types are permitted.

E. Additional Standards.

1. Loading and Garage Bays. Loading and Garage doors are considered blank walls.
2. Ground floor Standards:
 - a. A minimum of 30% of the ground floor, that portion of the structure closest to the street, must be utilized for non-residential uses.
 - b. Ground floor non-residential uses must be located along the front elevation.
3. Upper stories must be a residential use or office use.
4. Residential Units Factor:
 - a. Base = ~~1,200~~+250
 - b. 100% Affordable or Sustainable Design Standard = 900
5. Outdoor Amenity Space: 1/dwelling unit, may be shared.
6. The following Building Components may be used to increase the maximum Building Footprint by no more than 10 percent:
 - c. Side Wing (Sec. 3.3.2.F)
 - e-d. Rear Addition (Sec. 3.3.2.G)

3.2.12. Small Multi-Use Building

A. Description.

A small mixed-use building that has ground floor commercial activity along the frontage and either residential or commercial uses on the upper floors. Small multi-use building types are found in many village centers in Newton.

B. Building Dimensional Standards.

Building Width		Building Depth	Building Footprint	Number of Stories	Story Heights	
Min	Max	Max	Max	Max	Ground Story	Upper Stories
40 ft	100 ft	150 ft	12,000 sf	3 stories	Min 14 ft Max 24 ft	Min 10 ft Max 14 ft SP: +/- 2 ft

SP = Special Permit with mandatory Design Review (See Sec. 3.2.2)

C. Fenestration on the Front Elevation.

1. Ground Story Fenestration: 3050% Minimum
2. Upper Story Fenestration: 20% Minimum, 70% Maximum
3. Max Blank Wall = 20 ft x 20 ft
4. Principal non-residential Entrance Spacing: min. 1 entrance in each 40 ft of front elevation

D. Roof Types.

All Roof Types are permitted.

E. Additional Standards.

1. Loading and Garage Bays. Loading and Garage doors are considered blank walls.
2. Ground Story Non-residential Use Dimensional Standards:
 - a. A minimum of 50% of the ground story, that portion of the structure closest to the street, must be utilized for non-residential uses.
 - a-b. Ground story non-residential uses must be located along the front elevation.
 - b-c. Ground story non-residential use space must be a minimum depth of 50 ft or 60% of the building depth whichever is less.
 - c-d. The ground story non-residential use dimensional standards may be varied by Special Permit in accordance with Sec. 3.2.2.
3. Residential Units Factor:
 - a. Base = 1,200+250
 - b. 100% Affordable/Sustainable Design Standard = 900
4. Outdoor Amenity Space: 1/dwelling unit, may be shared.
5. The following Building Components may be used to increase the maximum Building Footprint by no more than 10 percent:
 - a. Side Wing (Sec. 3.3.2.F)
 - b. Rear Addition (Sec. 3.3.2.G)

3.2.13. Small Shop

A. Description:

A single-story commercial building, typically for a retail or service use. Small shop building types generally contain one, but may contain a few, smaller commercial establishments with an active frontage.

B. Building Dimensional Standards:

Building Width		Building Depth	Building Footprint	Number of Stories	Story Heights
Min	Max	Max	Max	Max	Ground Story
18 ft	100 ft	100 ft	7,000 sf	1.5 stories	Min 12 ft Max 24 ft

C. Fenestration on the Front Elevation:

- 1. Ground Story Fenestration: 60% Minimum
- 2. Max Blank Wall = 20 ft x 20 ft
- 3. Principal Entrance Spacing: min. 1 entrance in each 40 ft of front elevation

D. Roof Types:

All Roof Types with an equivalent of 0 or 0.5 stories are permitted.

E. Additional Standards:

- 1. Loading and Garage Bays. Loading and Garage doors are considered blank walls.
- 2. No residential uses.

3.2.14. Civic Building

A.—Description.

A landmark community building with a limited range of community-oriented uses, such as a building constructed for a religious or educational institution, or as a community center.

B.—Building Dimensional Standards:

Building Width		Building Depth	Building Footprint	Number of Stories	Story Heights
Min	Max	Max	Max	Max	All Stories
14 ft	300 ft	200 ft	30,000 sf	4-5 stories	Max 14 ft

C.—Fenestration on the Front Elevation:

- 1.—Ground Story Fenestration: 20% Minimum, 70% Maximum
- 2.—Upper Story Fenestration: 10% Minimum, 70% Maximum

D.—Roof Types:

All Roof Types are permitted.

E.—Additional Standards

- 1.—A Civic Building Type may only be occupied by Religious & Educational Uses Protected by M.G.L. 40A, Sec. 3 or Public Service Uses.
- 2.—A Civic Building Type may be converted to commercial or residential uses by Special Permit as described in Sec. 3.6.2 and Sec. 3.6.1.B.

3.3. Building Components.

3.3.1. Introduction and General Standards.

Building Components are accessory features that attach to the building type and increase the habitable square footage or enhance the usefulness of a building. These components provide an important means for achieving variety and individuality in design of building facades and are permitted as indicated for each building type. Building Components are permitted as specified in the table below. Building Components that are not identified in the table below are prohibited. Unless otherwise specified, Building Components may attach to other Building Components to create assemblies of components.

	<u>Bay</u>	<u>Balcony</u>	<u>Porch</u>	<u>Projected Entry</u>	<u>Corner Feature</u>	<u>Side Wing</u>	<u>Rear Addition</u>	<u>Dormer</u>	<u>Cross Gable</u>	<u>Roof Deck</u>
<u>House A</u>	P	P	P	P	P	P	P	P	P	P
<u>House B</u>	P	P	P	P	P	P	P	P	P	P
<u>House C</u>	P	P	P	P	P	P	P	P	P	P
<u>House D</u>	P	P	P	P	P	P	P	P	P	P
<u>Duplex</u>	P	P	P	P	P	P	P	P	P	P
<u>Triple Decker</u>	P	P	P	P	P	SP	SP	P	P	P
<u>Townhouse Section</u>	P	P	P	P	P	SP	SP	P	P	P
<u>Small Apartment House</u>	P	P	P	P	P	SP	SP	P	P	P
<u>Shop House</u>	P	P	P	P	P	SP	SP	P	P	P
<u>Small Multi-Unit Building</u>	P	P	P	P	P	SP	SP	P	P	P

P - Permitted

SP- Special Permit

3.3.2. Architectural Components ~~on the Front Elevation.~~

Any architectural components must be fully compliant with the setbacks and lot coverage requirements unless otherwise specified within the standards of that individual architectural component.

A. Bay.

1. **Description.** A bay is a window assembly extending from the main body of a building to permit increased light, provide multi-direction views, and articulate a building wall. Two Bays can connect around corners to create distinctive living space or terminate in an important axis.
2. **Dimensions.**

	Min	Max
--	-----	-----

Width (each bay)	-	Greater of 20% of wall length or 12 ft
Depth	-	3 ft
Fenestration	60%	-
Permitted Setback Encroachment		
Front	-	3 ft
Side & Rear	-	0 ft

3. Additional Standards.

- a. Bays may not cover more than 40% of the width of the front elevation on any story.
- b. In the Neighborhood General district, bays may project over the sidewalk of a public way under the following circumstances:
 - i. Bay must have a minimum of 20 ft clearance above the sidewalk.
 - ii. Permits for new bays over the public-way require written permission from the Commissioner of Public Works, verifying that the bay does not interfere with public infrastructure and maintenance needs.

B. Balcony.

- 1. Description. An unenclosed platform with a railing that provides outdoor amenity space on upper stories.
- 2. Dimensions.

	Min	Max
Width (each balcony)	5 ft	Greater of 20% of wall length or 12 ft
Depth	3 ft	8 ft
Clearance	10 ft	-
Permitted Setback Encroachment		
Front	-	3 ft
Side & Rear	-	0 ft

3. Additional Standards.

- a. Balconies may be recessed, projecting, or a combination of the two.
- b. The guard rail of any balcony oriented toward a front lot line must permit views of the public realm through the posts and rails with a maximum height of 48" for an opaque enclosure at the bottom of the guardrail.
- c. In the Neighborhood General district, balconies may project over the sidewalk of a public way under the following circumstances:
 - i. Balcony must have a minimum of 20 ft clearance above the sidewalk.
 - ii. Balcony may extend up to 3 ft over a sidewalk.
 - iii. Permits for new balconies over the public-way require written permission from the Commissioner of Public Works, verifying that the balcony does not interfere with public infrastructure and maintenance needs.

C. Front Porch.

- 1. Description. An unenclosed platform connected to a principal building that provides outdoor amenity space forward of the front elevation.
- 2. Dimensions.

	Min	Max
Width	8 ft	Same as Principal Building elevation width
Depth	6 ft	-
Permitted Setback Encroachment		
Front	-	6 ft
Side & Rear	-	0 ft

3. Standards.

- a. Stairs or ramp may encroach upon the front setback by a maximum of 4 feet beyond the front porch but must be at least 2 feet from the front property line.
- b. The guard rail of any front porch oriented toward a front lot line must permit views of the public realm through the posts and rails with a maximum height of 48" for an opaque enclosure at the bottom of the guardrail.
- c. A front porch may be screened or open.
- d. Front porches may include multiple levels for buildings of 2 or more stories, provided the footprint is the same as at the ground floor or reduced on upper stories.

D. Projecting ~~Front~~ Entry.

- 1. Description. An enclosed or unenclosed entry to a principal building.
- 2. Dimensions.

	Min	Max
Width	4 ft	8 ft or 20% of the Principal Building elevation whichever greater
Ceiling Height	-	12 ft
Permitted Setback Encroachment		
Front	-	4 ft
Side & Rear	-	0 ft

3. Standards.

- a. Uncovered stairs or ramp, at the minimal width required by building code, may encroach upon the front setback, but must be at least 2 feet from the front property line.

~~E. Turret:~~

- ~~1. Description. A small, decorative, tower-like extension from the wall or corner of a building, meant to provide distinctive living space or to terminate an important axis.~~
- ~~2. Dimensions:~~

	Min	Max
Width	6 ft	10 ft
Depth	6 ft	10 ft
Height	-	Stories equal to the principal building type
Fenestration	30%	-

Permitted Setback Encroachments		
Front	-	2-ft
Side	-	2-ft
Rear	-	-

~~3. Standards:~~

- ~~a. A building may include a maximum of one turret.~~
- ~~b. The highest point of the roof of a turret may be higher than the highest point of the roof of the primary building by up to 10%.~~

~~E. Turrets may wrap around corners.~~ Side Wing

- ~~1. Description. A multi-story extension from one or more side walls of a building. A Side Wing constitutes a Building Component only if its addition to the Main Massing of a Principal Building would exceed the maximum Building Footprint for that Building Type. A Side Wing added to a Principal Building that does not exceed the maximum Building Footprint for that Building Type shall be part of the Main Massing of the building.~~
- ~~2. Dimensions.~~

	Min	Max
Setback from Front Elevation	8 ft	=
Width	=	50% of the Front Elevation width
Depth	=	100% of the Front Elevation width
Height	=	Stories equal to the principal building type
Permitted Setback Encroachments		
Front	=	0 ft
Side & Rear	=	0 ft

~~3. Standards.~~

- ~~a. Side wings must include similarly style roof as the Principal Building.~~
- ~~b. Side wings may be centered or offset at the side wall of the Principal Building, provided they share at least 6 feet with the common wall.~~
- ~~c. A Side wing may be used for vehicular parking, provided it complies with Garage Design Standards (see Sec. 3.4.2).~~

F. Rear Addition

- ~~1. Description. A rear addition is an extension from the rear wall of a building. A Rear Addition constitutes a Building Component only if its addition to the Main Massing of a Principal Building would exceed the maximum Building Footprint for that Building Type. A Side Wing added to a Principal Building that does not exceed the maximum Building Footprint for that Building Type shall be part of the Main Massing of the building.~~
- ~~2. Dimensions.~~

	Min	Max
Width	=	Max width of rear wall, less 2 ft

Footprint	=	50% of Principal Building Footprint
Height	=	Stories equal to the principal building type
Permitted Setback Encroachments		
Front	=	0 ft
Side & Rear	=	0 ft

3. Standards.

- a. A rear addition may extend only backward from the rear of a building
- b. Rear additions may be centered or offset at the rear wall of the Principal Building, provided they share at least 6 feet with the common wall.
- c. The slope of any pitched roof of a rear addition must be equal to or less than slope of the roof of the Principal Building
- d. A rear addition may be used for vehicular parking, provided it complies with Garage Design Standards (see Sec. 3.4.2).

3.3.3. Roof Components.

A. Dormer.

1. **Description.** A **D**ormer is a windowed roof form that projects vertically from a sloped roof to provide light into and increase the habitable space of a half-story. **A** Dormer constitutes a Building Component only if its addition to the Main Massing of a Principal Building would exceed the maximum Number of Stories or Story Height for that Building Type. A dormer added to a Principal Building that does not exceed the maximum Number of Stories or Story Height for that Building Type shall be part of the Main Massing of the building.

2. Dimensions.

Width (max)	Window(s) width + 18 in
Side Wall Setback (min)	
Roof with eave	0 ft
Roof without eave	1 ft
Front and Rear Wall Setback	3 ft

- a. ~~A dormer may be no wider than 50 percent of the length of the exterior wall of the story next below. Where more than one dormer is located on the same side of the roof, the width of all dormers combined may not exceed 50 percent of the length of the exterior wall next below.~~
 - i. ~~A dormer on the rear wall of a House C may extend up to 75% of the length of the building wall below.~~
- b. ~~The vertical plane of the side wall of any dormer shall not be closer than 3 feet from the vertical plane of the intersection of the roof and the main building end wall nearest the dormer.~~

2.3. Standards.

- a. Dormers may be used with any roof with a minimum slope of 4:12 (18.43°) type, ~~except the flat roof.~~

- b. No dormer may extend above the roof ridge line.
- c. A dormer may be no wider than 50 percent of the length of the exterior wall of the story next below. Where more than one dormer is located on the same side of the roof, the width of all dormers combined may not exceed 50 percent of the length of the exterior wall next below.
- i. A dormer on the rear wall of a House C may extend up to 75% of the length of the building wall below.

B. Cross Gable.

1. **Description.** A cross gable is a sloped roof that projects perpendicularly from the main roof of a building to increase the habitable space of a half story or add architectural distinction to a ~~half-story, low-gabled roof.~~
2. **Dimensions.**
 - a. A Cross Gable may not exceed 50% of the eave length of the roof to which it connects.
3. **Standards.**
 - a. ~~A cross gable may only be used with half-story roofs (Sec. 2.6.3.D), a gable or low-gable roof type.~~
 - b. The ridge and eave of the cross gable must be structurally integrated into the ridge and eave of the principal building roof.

C. Roof Deck.

1. **Description.** A raised uncovered platform with a railing on the roof of a building that provides outdoor amenity space and access to views.
2. **Dimensions.**
 - a. The area of a roof deck may be up to the lesser of 400 square feet or 20% of the footprint of the building.
 - b. The width of a roof deck may not exceed 50% of the building width, except on a flat roof it may extend up to the full width of the roof.
 - c. A roof deck must be set at least 5 feet back from all building edges, and 10 feet from the front elevation. This standard is waived if the parapet wall is utilized as the roof deck guardrail, provided it is of sufficient height.
3. **Standards.**
 - a. The guardrail must be constructed with posts and rails with spacing such that it does not exceed 50% opacity, except when built on a flat roof.
 - b. The guardrail may be higher than the highest point of the roof of the primary building, up to the minimum height for a guard rail required by building code.

3.3.4. Accessory Structures.

A. General Standards.

1. **Definitions.**
 - a. **Accessory Structure.** A non-enclosed structure accessory to the principal building on the lot, such as a swing set or play structure.

- b. **Accessory Building.** An accessory building is a fully enclosed structure accessory to the principal building on the lot. (See Sec. 3.3.5)
- c. **Bounding Box.** The smallest rectangle that can enclose the accessory structure.
- 2. **Accessory Structure Placement.**
 - a. Unless otherwise specified, an accessory structure may encroach any side or rear setback, provided that at least 3 feet is maintained from any lot line.
 - b. Unless otherwise specified, accessory structures may be no nearer to any front lot line than the front elevation of the principal building.
 - c. Unless otherwise specified, any accessory structure, exceeding a bounding box of 150 square feet, must meet the setbacks for a principal building.
- B. **Accessory Garden Structures.**
 - 1. **Raised Planting Beds.**
 - a. Raised planting beds may be forward of the front elevation and may encroach the front setback, provided that at least 3 feet is maintained from any front lot line.
 - 2. **Pergola.**
 - a. A structure consisting of parallel colonnades supporting an open roof or girders and cross rafters, often shading an outdoor amenity area, or providing growing area for climbing plants.
 - b. A maximum of 1 pergola within a bounding box of 300 square feet may be located forward of the front elevation but must not be within the front setback.
 - i. A pergola within a bounding box of 300 square feet may encroach on the side and rear setbacks, provided that at least 5 feet is maintained from any lot line.
- C. **Accessory Art Structures.**
 - 1. Any artwork within any setback may not exceed 12 feet in height.
 - 2. Any artwork fitting within a bounding box of 100 square feet may be forward of the front elevation and may encroach the front setback, provided that at least 5 feet is maintained from any front lot line.
 - 3. Determination of whether an item qualifies as an artwork is to be made by the Director of the Mayor’s Office of Arts and Culture or their designee.
- D. **Accessory Athletic Structures.**
 - 1. Any permanent **or temporary** sport court or swimming pool must meet the setback requirements for a principal building.

3.3.5. Accessory Buildings.

- A. **General Standards.**
 - 1. **Definition.** An accessory building is a fully enclosed structure accessory to the principal building on the lot.
 - 2. Accessory buildings shall conform to the following dimensions:

Building Footprint	Number of Stories	Ground Story Height
--------------------	-------------------	---------------------

Max	Max	Max
700 sf	1.5 stories	18 ft

- a. No accessory building may exceed 22 feet in height from average grade to the peak of the roof.
- 3. Accessory Building Placement.
 - a. Unless noted for a specific accessory building type below, an accessory building shall be no nearer to any side or rear lot line than 5 feet, and no nearer to any front lot line than the front elevation of the principal building, unless otherwise specified for the lot type.
 - b. Accessory buildings must be separated from the principal building by at least 6 feet, measured from any surface of one to any surface of the other.
- 4. Accessory Garden Buildings.
 - a. Animal house. (e.g. dog house, horse barn)
 - i. Accessory buildings used for the keeping of animals must meet the setbacks for a principal building.
 - b. Greenhouse.
 - i. Permanent greenhouses exceeding 700300 square feet must meet the setbacks for a principal building.

3.4. Design Standards

~~3.4.1. Building Design Standards~~

~~A. Contextual Front Setback~~

~~Notwithstanding the front setbacks identified for each zoning district, new construction must have a contextual front setback as follows:~~

- ~~1. If the subject lot is an interior lot, the minimum and maximum front setbacks are equal to the actual distances that principal structures are set back from the front lot line on the two abutting lots of the same block face. See Figure 3.1 (a).~~
- ~~2. If the subject lot is a corner lot, the minimum front setback is equal to the actual distance that the principal structure is set back from the front lot line on the abutting lot that is oriented toward the same thoroughfare.~~
- ~~3. The contextual front setback provision does not exempt any building from complying with the maximum front setback required for each zoning district.~~

3.4.1. Garage Design Standards

A. Purpose.

- 1. To prevent garages from obscuring the main entrance from the street and ensure that there is a physical and visual connection between the living area of residential buildings and the street;
- 2. Ensure that the location and amount of living areas of residential buildings, as seen from the street, are more prominent than structured parking or garages;
- 3. Ensure that the main entrance for pedestrians, rather than motor vehicles, is the prominent entrance;

- 4. Provide for a more pleasant pedestrian environment by preventing garages from dominating the views of the neighborhood from the sidewalk; and
- 5. Enhance public safety by preventing garages from blocking views of the street from inside the residence.

B. Applicability.

Garage Design Standards apply in all Residence Districts

C. Garage, defined.

An attached or detached structure designed primarily for the storage or parking of one or more automobiles. A detached garage is an accessory building (See Sec. 3.3.4).

- 1. Front Facing Garage. A garage, where the primary door or doors through which automobiles enter the garage faces the Primary Front Lot Line. On corner lots, a Front Facing Garage faces the Primary Front Lot Line.
- 2. Side Facing Garage. A garage, where the primary door or doors through which automobiles enter the garage faces the Primary Front Lot Line at an angle between 45 and 90 degrees.
- 3. Garage Wall. Any wall enclosing a garage including that wall containing the garage entrance.

D. General Standards

- 1. A Front Facing Garage may be no closer to the Primary Front Lot Line than 8 feet behind the Front Elevation of the building, except as follow:
 - a. A garage may be up to 6 feet in front of the Front Elevation if there is a Front Porch at the main entrance, but no closer to the Primary Front Lot Line than the Front Porch, so long as the Front Porch meets the following:
 - i. The Front Porch must be a minimum of 48 square feet in area, with no dimension less than 6 feet;
 - ii. The Front Porch must have a solid roof; and
 - iii. The roof may be no more than 12 feet above the floor of the Front Porch.
- 2. Garage doors on a Front Facing Garage providing spaces for 2 or more motor vehicles must provide individual doors for each space at a maximum width of 9 feet.
- 3. A Side Facing Garage may be located in front of the building Front Elevation, but not within the front setback, if it meets the following:
 - a. Fenestrations on the Garage Wall elevation facing the Primary Front Lot Line, 20% minimum, 50% maximum; and
 - b. The garage roof type and roof components, if applicable, match or complement the primary building.
- 4. Where the building Front Elevation is less than 22 feet long, an attached garage is not allowed as part of that elevation.

E. Additional Standards for one-unit residential Building Types.

- 1. There may be no more than 700 square feet in total garage space on a lot providing for no more than 3 motor vehicles, between a maximum of one attached garage and one detached garage.

- 2. The length of an attached garage facing the Primary Front Lot Line may be up to 50% of the width of the Front Elevation or 12 feet, whichever is greater.
 - a. On corner lots, only one street- or right-of-way-facing garage wall must meet the standards of this subsection.

F. Additional Standards for residential Building Types with two-units or more.

Parking spaces in garages are counted toward the minimum number of accessory parking spaces required by Sec. 3.7. Garages may be attached or detached.

1. Attached Garages.

- a. For each residential unit, there shall be no more than one attached garage and an attached garage shall provide for no more than 2 motor vehicles.
- b. The length of an attached garage, or attached garages, facing the Primary Front Lot Line may be up to 50% of the total Front Elevation or 24 feet, whichever is greater.

2. Detached Garages. Centralized and underground garages are encouraged.

- a. The number of detached garages on a property may not exceed one half of the number of units on the property, rounded down.
- b. A detached garage of more than 700 square feet and providing for more than 3 vehicles is allowed by right if it meets the setbacks for a principal building.
- c. By Special Permit, a detached garage of more than 700 square feet may be located within the setback, provided a minimum of 5 feet from the property line is maintained.
- d. Review Criteria. In its discretion to approve or deny a Special Permit authorizing a detached garage in the setback, the Special Permit Granting Authority must find the application meets the following criteria:
 - i. The criteria for all Special Permits specified in Sec. 11.4.3.
 - ii. Design and siting are compatible with the neighborhood and adjacent residential properties.
 - iii. Strategies such as screening, landscaping, and window placement reduce effects on neighboring properties.

G. Exemptions.

- 1. In R1 districts where the house is more than 70 feet from the Primary Front Lot Line are exempt from the standards of this section.
- 2. Garages on lots which slope up or down from the Primary Front Lot Line with an average slope of 20% or more are exempt from the standards of this subsection.

3.5. Alternate Lot/Building Configurations

3.5.1. Rear Lots

- A. Purpose. The intent of this section is to diversify housing choices in the city while respecting the residential character and scale of existing neighborhoods. Rear Lot development allows for particularly deep residential lots to create an additional residential unit that is subordinate to the principal building.

A-B. Defined. A lot that has no or substandard frontage on a street, which has access to a street by either:

1. A "flag pole" or "pan-handle" shaped portion of the lot that is narrower than the minimum lot width and has street frontage, or
2. An easement over an adjoining lot that has street frontage.

B-C. Standards.

1. A rear lot may only be created from an interior lot.
2. A rear lot must meet the lot frontage, lot depth, setback, and lot coverage standards of the existing interior lot and the proposed rear lot.
3. The front lot line of a rear lot may be either:
 - a. The rear lot line of the adjoining lot fronting the street; or
 - b. A lot line parallel to the driveway and perpendicular to the street as designated by the property owner at the time of the special permit application.
 - c. Minimum lot frontage is measured along this line.
4. No newly-created rear lot may create a non-conformity on the front lot. If the front lot does not have an existing principal building or is proposed for development/ redevelopment at the same time as the creation of the rear lot, the following minimum depth for the front lot is required in each district:

a. Residence 1:	100 ft
b. Residence 2:	75 ft
c. Residence 3:	75 ft
e-d. Residence 4:	75 ft
d-e. Neighborhood General:	100 ft

~~5. A building type placed on a rear lot configured according to 3.6.1.B.3.a must be placed such that no more than 50% of the building width is behind the building on the lot fronting the street, as viewed in a direct line from the existing interior lot and the proposed rear lot.~~

~~6.5.~~ Only a House C building type may be placed on a rear lot.

E-D. Review Criteria. The creation of a rear lot requires a special permit from the Planning Board designated Special Permit Granting Authority in accordance with the procedures described in Article 11. In its discretion to approve or deny a special permit authorizing the creation of a rear lot, the Special Permit Granting Authority must find that the application meets the following criteria:

1. The criteria for all Special Permits specified in Sec. 11.4.3.
2. Design and landscaping are compatible with the neighborhood and adjacent properties.
3. Landscaping and other screening strategies serve to clearly delineate the private yards of the proposed dwelling on the rear lot and that of buildings on abutting lots.
4. Access to the rear lot is sufficient to accommodate public safety needs.

3.5.2. Multi-Unit Conversion

A. Purpose. The intent of this section is to diversify housing choices in the city while respecting the residential character and scale of existing neighborhoods by incentivizing the conversion of existing single-family building types into multi-family structures with minimal exterior alterations allowed.

B. Building Types.

The following building types may be altered or renovated to increase the number of residential units up to the maximum permitted by Sec. 3.5.2.C herein:

- 1. House A (Sec. 3.2.3)
- 2. House B (Sec. 3.2.4)
- 3. House D (Sec. 3.2.6)

~~An existing House A or Civic building type may be altered or renovated to install or increase the permitted number of residential units by special permit in accordance with the procedures described in Article 11.~~

C. No exterior alterations of the structure are allowed, except:

- 1. Building Components (See Sec. 3.3); or
- ~~2. Those necessary to comply with applicable Health, Building, and Fire codes~~

~~D. The Special Permit Granting Authority is determined by the scale of the project (See Secs. 3.1).~~

~~The building must have been built at least 10 years prior to the date of application.~~

E.D. The maximum number of residential units allowed in a building is subject to the following residential unit factors:

- 1. Base RU Factor = ~~1200~~1250
- 2. 100% Affordable/Sustainable Design Standard RU Factor = 900

F.E. Development Review. Depending on the scale, a Multi-Unit Conversion may be by-right or require a Special Permit.

- 1. By Right. A Multi-Unit Conversion is by-right if it includes no more than 6 dwelling units.
- 2. By Special Permit. Multi-Unit Conversions with more than the by right number of units require a special permit. The Special Permit Granting Authority is determined by the scale of the project in accordance with Sec. 3.1.1.D.
 - a. Review Criteria. In its discretion to approve or deny a special permit authorizing multi-unit conversion of an existing building, the Special Permit Granting Authority must find that the application meets the following criteria:
 - i. The criteria for all Special Permits specified in Sec. 11.4.3.
 - ii. Preservation of the existing building's design integrity, with special attention to important historic features or components of the building.
 - iii. Design and landscaping are compatible with the neighborhood and adjacent properties.
 - iv. Preservation and/or enhancement of landscaped areas and trees, especially to serve as a buffer to neighboring lots.

- v. ~~On and Off~~-street parking available provides an adequate supply of parking (~~Sec. 3.7 drawing guidance from existing standards in the Newton Zoning Ordinance~~) while also minimizing the presence of large parking areas and extensive areas of pavement.

3.5.3. Courtyard Cluster

~~A. Purpose. The intent of this section is to provide an alternative housing option that promotes community interaction through compact living clustered around a semi-private shared open space. Because of the smaller than typical residential building types, Courtyard Cluster development is meant to provide a non-subsidized form of housing that is generally less expensive than similar rental units in multi-family buildings. Courtyard Clusters can provide flexibility for families as their needs change over time and, in particular, provide options for seniors looking to downsize.~~

~~A.B. Defined.~~ A series of smaller than typical residential building types surrounding a shared courtyard green space. The Courtyard Cluster is scaled to fit within neighborhoods of residential building types and provide units that are smaller than average for the area in a setting where some features, like parking and outdoor amenity spaces, are located in common facilities.

~~B.C. Standards.~~

1. ~~Lot Standards.~~

District	Lot Size	Lot Frontage	Lot Coverage
	Min	Min	Max
R1	1 ac	50 ft	30%
R2	1 ac	50 ft	40%
R3	.75 ac	50 ft	50%
R4	.75 ac	50 ft	50%
N	.75 ac	50 ft	60%

2. ~~Building Types and Additional Standards.~~ The following building types may be used in a courtyard cluster. Unless varied by the standards listed here, all other standards for each building type apply.

District	Building Types	Footprint Limits
		Max.
Residence 1	House C	1200 sf
	House D	1400 sf
Residence 2	House C House B	1200 sf
Residence 3	House C House B Two-Unit Residence	1200 sf
Residence 4	House C House B Duplex Two-Unit Residence	1200 sf
Neighborhood General	House B House C Duplex Two-Unit Residence	House B: 1200 sf House C: 1200 sf Duplex: 1400 sf Triple Decker: 1400 sf

	Triple Decker 3-Unit Building	
--	----------------------------------	--

3. Buildings must front the courtyard or the public street. No building may orient a rear wall to the courtyard or street.
4. Courtyard Requirements.
 - a. A minimum of 400 square feet per unit of courtyard is required with a minimum width and depth of 20 feet.
 - b. At least 50% of the buildings must abut the courtyard.
 - c. All buildings must be within 60 feet of the courtyard as measured from the front door to the edge of the courtyard.
 - d. The courtyard must have buildings abutting at least two sides.
5. Courtyard clusters may not contain streets.
6. Driveways may not be located between any building and the court.
7. Parking.
 - a. Parking may be located in or under a building, in a surface lot, or in detached garages, provided that parking is screened from view from adjoining properties and the street.
 - b. Parking may be located between any two buildings and a rear or side lot line.
8. An existing House A, House B, House C, House D, Two-Unit Residence, 3-Unit Building, or Shop House which may be non-conforming with respect to the standards of this section, shall be permitted to remain, but the extent of the non-conformity with the courtyard cluster requirements may not be increased.

C.D. Review Criteria. A Courtyard Cluster requires a Special Permit in accordance with the procedures described in Article 11. In its discretion to approve or deny a special permit authorizing a courtyard cluster, the Special Permit Granting Authority must find that the application meets the following criteria:

1. The criteria for all Special Permits specified in Sec. 11.4.3.
2. Design and landscaping are compatible with the neighborhood and adjacent properties.
3. The landscaped areas and trees are preserved and/or enhanced, especially to serve as a buffer to neighboring lots.
4. ~~On and Off~~-street parking available provides an adequate supply of parking (~~drawing guidance from existing standards in the Newton Zoning Ordinance Sec. 3.7~~) while also minimizing the presence of large parking areas and extensive areas of pavement.

3.5.4. Multi-Building Assemblage

- A. Purpose. The intent of this section is to allow multiple principle building types to be built on a single lot. Buildings in an assemblage present and function as individual structures with varied character in order to lend visual interest and vibrancy to the mixed-use areas in which they are built.
- B. Assemblage, defined. An assemblage is a series of attached or ~~related detached~~ buildings, assembling multiple principal building types on one lot, or a series of connected lots.

C. Standards.

Multi-building Assemblage is allowed in the Neighborhood General (N) district in accordance with the following standards:

1. All lot standards must be met.
2. Buildings may be attached within the setbacks.
3. Each building in the assemblage must meet the standards for a building type allowed in the Neighborhood General District.
4. Townhouse Sections must be in a series of at least 23 but no more 8 sections.
5. All building front elevations must front on private- or public-ways.
6. If buildings are attached, the front elevation setbacks from the front lot line must vary after every 3 adjacent buildings by at least 4 feet.
7. All buildings must have individual entrances. Except as allowed below, no building may be accessed through an adjacent building.
 - a. Underground parking may be connected and shared.
 - b. Ground floor non-residential spaces may be combined between adjacent buildings.
 - c. Floor-to-floor connections on upper stories may be allowed between attached buildings in an assemblage by special permit in accordance with Sec. 3.2.2. In addition to the criteria described in Article 11, the Special Permit Granting Authority shall consider the purpose of this section 3.5.4.
8. No more than 2 adjacent buildings, with the exception of a series of townhouses, may have the same primary roof orientation and/or type.
9. Each assemblage with a mix of commercial and residential uses with a total of more than 60 dwelling units must contain a minimum of 1 public gathering space adjacent to a public-way, in accordance with Sec. 2.10.

D. **Development Review.** Depending on the scale, a Multi-Building Assemblage may be by right or require a special permit.

1. **By Right.** An assemblage is by-right if it includes no more than 68 dwelling units or 8,000 square feet of commercial space.
2. **By Special Permit.** Multi-building assemblages with more than the by right number of units or square footage of commercial space require a special permit. The Special Permit Granting Authority is determined by the scale of the project in accordance with Sec. 3.1.1.D.
 - a. **Review Criteria.** In addition to the criteria described in Article 11, the Special Permit Granting Authority shall consider the purpose of this Sec. 3.5.4.

3.6. Allowed Uses.

3.6.1. General Standards for Allowed Uses in the Residence Districts.

A. Permitted Uses

1. The use of real property is subject to the provisions of Article 9 Use Regulations.
2. Uses are permitted as specified in Sec. 3.6.2.
3. Use categories not expressly authorized are prohibited.

- 4. Uses permitted by Special Permit require additional development review in accordance with Article 9 and Article 11.
- 5. Number of residential units allowed and the size of building permitted is subject to the Building Type rules in Sec. 3.2.

B. Adaptive Reuse of Existing Buildings

The use of any principal building constructed before the effective date of this Ordinance may be changed by Special Permit from the ~~determined Special Permit Granting Authority Planning Board~~ to include any use within the following principal use categories in accordance with the table in 3.6.2 and according to the requirements and processes of Article 9 and Article 11.

Commented [ZL6]: City staff is working with the Economic Development Director and other Boards/Commissions on guidance of how to update this regulation.

- 1. The following use categories are allowed:
 - a. Arts Exhibition
 - b. Art Sales & Services
 - c. Community Center
 - d. Museum
 - e. Shared Workspaces & Arts Education
 - f. Restaurant/Café
 - g. General Office
- 2. **Review Criteria.** In its discretion to approve or deny a special permit authorizing an adaptive reuse of an existing building, the Special Permit Granting Authority must find that the application meets the following criteria:
 - a. The criteria for all Special Permits specified in Sec. 11.4.3.
 - b. Design, landscaping, and property management strategies are compatible with the neighborhood and adjacent residential properties.
 - c. Location relative to the transportation system, ensuring that the proposed customer base, clients, and/or suppliers, can readily get to the proposed location while minimizing disruption to the neighborhood.
 - d. On and off-street parking available provides an adequate supply of parking (drawing guidance from existing standards in the Newton Zoning Ordinance) while also minimizing the presence of large parking areas and extensive areas of pavement.
 - e. Preservation and/or enhancement of landscaped areas and trees, especially to serve as a buffer to neighboring lots.

C. Permitted Accessory Uses.

- 1. The use of real property is subject to the provisions of Article 9 Use Regulations.
- 2. Accessory Uses permitted by Special Permit require additional development review in accordance with Article 9 and Article 11.

3.6.2. Use Table.

The following use categories and specific uses are permitted in the Residence Districts:

Use Category Specific Use	R1	R2	R3	R4	N	Definitions & Use Specific Standards

Residential Use Categories					
Household Living Uses	P	P	P	<u>P</u>	P
Group Living Uses (except as follows)	SP	SP	SP	<u>SP</u>	SP
• Community / Group Residence	P	P	P	<u>P</u>	P
• Dormitory, Student Residences	SP	SP	SP	<u>SP</u>	SP
• Lodging House	N	N	SP	<u>SP</u>	SP
• Nursing Home / Assisted Living Facility	SP	SP	SP	<u>SP</u>	SP
Arts & Creative Enterprise Use Categories					
Artisan Production Uses	N	N	N	<u>SP</u>	P
Arts Exhibition Uses	SP	N	N	<u>N</u>	SP
Arts, Sales & Service Uses	SP	SP	SP	<u>SP</u>	P
Shared Workspaces & Arts Education Uses	SP	N	N	<u>SP</u>	SP
Work/Live Creative Studio Uses	N	N	N	<u>SP</u>	P
Civic & Institutional Use Categories					
Community Center Uses	SP	SP	SP	<u>SP</u>	SP
Minor Utility Uses	SP	SP	SP	<u>SP</u>	SP
Major Utility Uses	SP	SP	SP	<u>SP</u>	SP
Museum Uses	SP	SP	SP	<u>SP</u>	SP
Private, Non-profit Club or Lodge Uses	SP	SP	SP	<u>SP</u>	SP
Public Service Uses	P	P	P	<u>P</u>	P
Religious & Educational Uses Protected by M.G.L. 40A. Sec. 3	L	L	L	<u>L</u>	L
Commercial Service Use Categories					
Animal Service Uses (as noted below)	-	-	-		-
• Veterinarian	N	N	N	<u>N</u>	SP
Banking & Financial Service Uses	N	N	N	<u>N</u>	SP
Building & Home Repair Service Uses	N	N	N	<u>N</u>	P
Business Support Service Uses	N	N	N	<u>N</u>	P
Day Care Service Uses (as noted below)	--	--	--	<u>=</u>	--
• Adult Day Care Center	SP	SP	SP	<u>SP</u>	SP
• Child Day Care Center	P	P	P	<u>P</u>	P
Educational Institution Uses	SP	SP	SP	<u>SP</u>	SP
Maintenance & Repair of Consumer Goods Uses	N	N	N	<u>N</u>	SP

Personal Service Uses (as noted below)	-	-	-	<u>==</u>	-	
• Funeral Home	N	N	N	<u>N</u>	P	
• Health Care Provider	N	N	N	<u>N</u>	SP	
Eating and Drinking Use Categories						
Restaurant/Café Uses	SP	SP	SP	<u>SP</u>	SP	
Lodging Use Categories						
Bed & Breakfast Uses	SP	SP	SP	<u>SP</u>	SP	
Motor Vehicle-Oriented Use Categories						
Motor Vehicle Parking Uses (as noted below)	--	--	--		--	
• Off-Site Accessory Parking	N	N	N	<u>N</u>	SP	
Office Use Categories						
Co-Working Uses	N	N	N	<u>N</u>	P	
General Office Uses	SP	SP	SP	<u>SP</u>	P	
Open Space Use Categories						
Farming Uses	P	P	P	<u>P</u>	P	
• Community Gardening	P	P	P	<u>P</u>	P	
Private Cemetery Uses	P	P	P	<u>P</u>	P	
Resource Extraction Uses	SP	SP	SP	<u>SP</u>	SP	
Retail Sales Use Categories						
Consumer Goods Uses (Except as Follows)	N	N	N	<u>N</u>	P	
• Fresh Food Market or Grocery Store	N	N	N	<u>N</u>	P	
• Farmer/Vendor Market	N	N	N	<u>N</u>	P	
Accessory Uses	R1	R2	R3	<u>R4</u>	N	
Uses typically found as accessory to permitted principal uses.	P	P	P	<u>P</u>	P	
Uses typically found as accessory to household living.	P	P	P	<u>P</u>	P	
Accessory Apartment	--	--	--	<u>==</u>	--	
• Internal	P	P	P	<u>P</u>	P	
• Detached	SP	SP	SP	<u>SP</u>	SP	
A.T.M.	N	N	N	<u>N</u>	P	
Car Share & Bike Share	N	N	N	<u>SP</u>	P	
Commercial Vehicle Parking	P	P	P	<u>P</u>	P	
Home Business Uses	P	P	P	<u>P</u>	P	
• Day Care	P	P	P	<u>P</u>	P	
Short Term Rental	P	P	P	<u>P</u>	P	
P = Permitted, N = Not Allowed, L = Allowed with Limitations, SP = Special Permit						

3.7. Parking Requirements in the Residence Districts.

3.7.1. General Standards.

A. Required Accessory Parking Spaces.

Vehicular and bicycle parking must be provided as specified in Sec. 3.7.3, except as follows:

1. 1- and 2-unit residential buildings are exempt from the requirements of Sec. 3.7.3.
2. Ground story non-residential uses with 5,000 square feet or less of gross leasable floor area are exempt from the requirements of Sec. 3.7.3.
3. There are no parking requirements for accessory uses.
4. Parking may be shared between uses on the same lot and buildings within 500 linear feet as measured along the street in accordance with Article 8.
5. One on-street parking space, where permitted, for every 20 feet of lot width may be counted toward any minimum parking requirement for all allowed use categories, except residential use categories.

B. Vehicular Parking Space Types.

Accessory motor vehicle parking spaces may be provided as off-street surface parking spaces, structured parking spaces, and on-street parking spaces.

C. Unbundled Market Rate Parking.

1. Off-street motor vehicle parking spaces must be rented, leased, or sold as a separate option rather than a requirement of the rental, lease, or purchase of a residential unit or non-residential floor space.
2. Bicycle parking must be provided at no cost or fee to customers, visitors, employees, tenants, and residents.

D. Parking Design.

The design of all parking is subject to Article 8 of this Ordinance.

E. Driveway Access.

1. Driveways must be paved with paving stones, grass pavers, pervious concrete, or porous asphalt unless graded to direct runoff onto onsite permeable areas or granted a waiver by the City Engineer to mitigate adverse site conditions.
 - a. Ribbon driveways are highly encouraged
2. Ribbon Driveways must have paved tracks that are at least 2 feet in width and 5 feet on center with an unpaved area that is at least 3 feet in width.
3. Driveways may provide access from a front, side, or rear lot line and may be located within required front or rear setback areas. Driveways may be located within the required side setback area provided the driveways are located at least 3 feet from the side lot line.
4. No parking stall may be located within any required setback area, with the exception that up to 2 parking stalls may be located in a side setback area. No parking stall may be located between the building front elevation and the street.
5. For a minimum of 10 feet measured from the lot line where the driveway is accessed into the lot, driveways may be no wider than 10 feet if providing one-way access to a parking area for residential Building Types with eight-units or less and

no wider than 20 feet if providing two-way access to a parking area for residential Building Types with nine-units or more.

a. Driveways widths may increase beyond the minimum 10 feet measured from the lot line where the driveway is accessed to allow for motor vehicles to back-in and back-out.

6. Driveways may provide access in whole or in part on or across an abutting lot(s), provided that an access easement exists among all affected property owners.

7. Only one curb cut is permitted per Lot, except:

a. A maximum of two curb cuts are permitted on a Lot with a residential Building Type with two-units or more, when a minimum distance of 35 feet between each curb cut is maintained.

b. Corner Lots and Through Lots may have a maximum of one curb cut per Front Lot Line.

8. Curb cuts must be located to minimize conflict with pedestrians, bicyclists, and motor vehicles on the thoroughfare they provide access to and from.

a. Curb cuts for residential driveways should be at least 20 feet from an unsignalized intersection and at least 40 feet from a signalized intersection.

9. Curb cuts may be no wider than 12 feet if providing one-way access to a parking area for residential Building Types with eight-units or less and no wider than 22 feet if providing two-way access to a parking area for residential Building types with nine-units or more, excluding flares or returned curbs.

10. The grade, cross slope, and clear width of the walkway of a sidewalk must be maintained between the driveway apron and the abutting driveway. The appearance of the walkway (i.e. scoring pattern or paving material) must indicate that, although a vehicle may cross, the area traversed by a vehicle remains part of the sidewalk.

F. Off-site Parking on a Contiguous Lot.

Required accessory vehicular parking spaces, excluding required parking for disabled persons, may be provided on a contiguous lot under the same ownership as the lot that the parking will serve with a Special Permit.

1. The following additional standards apply:

- a. Pedestrian access to off-site vehicular parking must be via a paved sidewalk or walkway.
- b. A lease, recorded covenant, or other comparable legal instrument guaranteeing long term use of the site must be provided to the Special Permit Granting Authority or Commissioner of Inspectional Services, as appropriate, and executed and filed with the Registry of Deeds.

3.7.2. Parking Relief

- A. Relief from the number of required accessory parking spaces in Sec. 3.7.3. requires a special permit from the determined Special Permit Granting Authority~~Planning Board~~.
- B. **Review Criteria.** In its discretion to approve or deny a special permit authorizing relief from the parking standards of Sec. 3.7.3, the Special Permit Granting Authority must find that the application meets the following criteria:
 - 1. The supply and demand of on-street parking in the neighborhood is adequate, as determined through a parking study.

2. Mobility management programs and services have been provided by the applicant to reduce the demand for parking.
3. There is availability and access to public transportation options.
4. That parking provided in excess of any maximum permitted must be paved with paving stones, grass pavers, pervious concrete, or porous asphalt, does not result in the increase in impervious lot area.

3.7.3. Required Number of Accessory Parking Spaces.

The following standards for accessory bicycle and motor vehicle parking spaces are associated with the use categories permitted in the Residence Districts:

Use Category Specific Use	Bicycle Parking		Motor Vehicle	
	Short (min)	Long (min)	Min	Max
Residential Use Categories				
Household Living Uses	-	0.5 / DU	1.0 / DU	2.0 / DU
Group Living Uses	0.5 / DU	0.1 / DU	1.0 / DU	2.0 / DU
Arts & Creative Enterprise Use Categories				
Artisan Production Uses	-	1.0 / 2,500 sf	1.0 / 1,000 sf	2.0 / 1,000 sf
Arts Exhibition Uses	1.0 / 10,000 sf	1.0 / 3,000 sf	1.0 / 1,000 sf	4.0 / 1,000 sf
Arts, Sales & Service Uses	1.0 / 10,000 sf	1.0 / 3,000 sf	1.0 / 1,000 sf	4.0 / 1,000 sf
Shared Workspaces & Arts Education Uses	1.0 / 10,000 sf	1.0 / 3,000 sf	1.0 / 1,000 sf	4.0 / 1,000 sf
Work/Live Creative Studio Uses	0.5 / DU	0.1 / DU	1.0 / DU	2.0 / DU
Civic & Institutional Use Categories				
Community Center Uses	1.0 / 5,000 sf	1.0 / 2,500 sf	2.0 / 1,000 sf	5.0 / 1,000 sf
Minor Utility Uses	n/a	n/a	n/a	n/a
Major Utility Uses	-	-	-	-
Museum Uses	1.0 / 10,000 sf	1.0 / 3,000 sf	2.0 / 1,000 sf	5.0 / 1,000 sf
Private, Non-profit Club or Lodge Uses	1.0 / 5,000 sf	1.0 / 2,500 sf	2.0 / 1,000 sf	4.0 / 1,000 sf
Public Service Uses	-	-	-	-
Religious & Educational Uses Protected by M.G.L. 40A. Sec. 3	1.0 / 1,000 sf	1.0 / 2,500	2.0 / 1,000 sf	8.0 / 1,000 sf
Commercial Services Use Categories				
Animal Services Uses	1.0 / 5,000 sf	1.0 / 2,500 sf	2.0 / 1,000 sf	3.5 / 1,000 sf
Banking & Financial Services Uses	1.0 / 5,000 sf	1.0 / 2,000 sf	1.5 / 1,000 sf	3.5 / 1,000 sf
Building & Home Repair Service Uses	-	1.0 / 2,500 sf	1.0 / 1,000 sf	2 / 1,000 sf

Business Support Service Uses	1.0 / 2,000 sf	1.0 / 2,500 sf	1.0 / 1,000 sf	3.0 / 1,000 sf
Day Care Service Uses	1.0 / 5,000 sf	1.0 / 1,000 sf	1.5 / 1,000 sf	3.0 / 1,000 sf
Educational Institution Uses	1.0 / 1,000 sf	1.0 / 2,000 sf	1.0 / 1,000 sf	4.0 / 1,000 sf
Maintenance & Repair of Consumer Goods Uses	1.0 / 5,000 sf	1.0 / 2,500 sf	1.0 / 1,000 sf	3.0 / 1,000 sf
Personal Service Uses	1.0 / 1,000 sf	1.0 / 2,500 sf	2.0 / 1,000 sf	4.0 / 1,000 sf
Eating and Drinking Use Categories				
Restaurant/Café Uses	1.0 / 2,000 sf	1.0 / 2,000 sf	4.0 / 1,000 sf	8.0 / 1,000 sf
Lodging Use Categories				
Bed & Breakfast Uses	-	-	1.0 / bedroom	3 + 1.0 / bedroom
Motor Vehicle Oriented Uses				
Motor Vehicle Parking Uses	-	-	-	-
Office Use Categories				
Co-Working Uses	1.0 / 5,000 sf	1.0 / 2,000 sf	1.5 / 1,000 sf	3.5 / 1,000 sf
General Office Uses	1.0 / 5,000 sf	1.0 / 2,000 sf	1.0 / 1,000 sf	2.5 / 1,000 sf
Open Space Use Categories				
Farming Uses	-	-	-	-
Private Cemetery Uses	-	-	-	-
Resource Extraction Uses	-	-	-	-
Retail Sales Use Categories				
Consumer Goods Uses	1.0 / 2,000 sf	1.0 / 2,500 sf	1.0 / 1,000 sf	3.0 / 1,000 sf

The table below represents the revisions and updates made to Article 3 - Residence Districts from the draft shared in the March 9, 2020 ZAP memo, titled **Version 2 - 02/28/20**. The original draft of Article 3 - Residence Districts was released in October 2018.

Section	Previous Recommendation	Proposed Recommendation	Goal, Problem Addressed, or Reasoning
3.1.1.D	Table specified the Special Permit Granting Authority depending on the scale/threshold of proposed development	Make this a [Reserved] section to be discussed as part of the larger discussion on Article 11 - Administration	To simplify and streamline the permitting review process remains an overall goal. However, attempting to tackle development review and overhauling the zoning code at the same time does not allow for the necessary focus each item needs individually.
3.1.2.C - 3.1.2.D	Lot and Setback Standards were split into two different bullets. "Contextual Front Setback (sec. 3.4.1.A)" states as a rule.	Combine 3.1.2.C (Lot Standards) and 3.1.2.D (Setback Standards) into one bullet titled "Dimensional Standards". Remove "Contextual Front Setback" and instead make the minimum-maximum range of front setback the rule.	"Dimensional Standards" is the language used in the current Zoning Ordinance. Being consistent with language, when possible, will simplify the transition to the new code. Similarly, Contextual Front Setback is an option found in the current Zoning Ordinance. Making it a rule in the draft is not necessary because each district sets a minimum and a maximum front setback (range), that is contextual. This recommendations simplifies the code.
3.1.2.E.1.c	Allow for the alternative lot/building configuration development of Courtyard Cluster in R1	Remove the alternative lot/building configuration development of Courtyard Cluster in R1	As it relates to the overall goals, and comments received at ZAP meetings, the Planning Department recommends that Courtyard Cluster development be focused in areas close to public transit and village centers
3.1.3.C - 3.1.3.D	See 3.1.2.C-3.1.2.D "Dimensional Standards" and "Contextual Front Setback"	See 3.1.2.C-3.1.2.D "Dimensional Standards" and "Contextual Front Setback"	See 3.1.2.C-3.1.2.D "Dimensional Standards" and "Contextual Front Setback"

Zoning Redesign

Article 3 - Residence District, Change Log

Section	Previous Recommendation	Proposed Recommendation	Goal, Problem Addressed, or Reasoning
3.1.3.E.2.b.i	Special Permit criteria language for allowing House Type D in R2 stated, "methods to address energy efficiency are sufficiently employed."	Special Permit criteria language for allowing House Type D in R2 changed to, "the site and building as designed, constructed, and operated will contribute significantly to the efficient use and conservation of natural resources and energy."	New language is clearer and pulls from recent updates to the Criterion 5 language. Added criteria focused on sustainability acknowledges that the House D, as a large footprint/single-story building, is not the most efficient building form.
3.1.3.E.1.c	See 3.1.2.E.1.c "Courtyard Cluster"	See 3.1.2.E.1.c "Courtyard Cluster"	See 3.1.2.E.1.c "Courtyard Cluster"
3.1.4.C - 3.1.4.D	See 3.1.2.C-3.1.2.D "Dimensional Standards" and "Contextual Front Setback"	See 3.1.2.C-3.1.2.D "Dimensional Standards" and "Contextual Front Setback"	See 3.1.2.C-3.1.2.D "Dimensional Standards" and "Contextual Front Setback"
3.1.4.E.1.c	See 3.1.2.E.1.c "Courtyard Cluster"	See 3.1.2.E.1.c "Courtyard Cluster"	See 3.1.2.E.1.c "Courtyard Cluster"
3.1.5.C - 3.1.5.D	See 3.1.2.C-3.1.2.D "Dimensional Standards" and "Contextual Front Setback"	See 3.1.2.C-3.1.2.D "Dimensional Standards" and "Contextual Front Setback"	See 3.1.2.C-3.1.2.D "Dimensional Standards" and "Contextual Front Setback"
3.1.5.C	Minimum Lot Frontage = 40ft, Side Setback = 7.5ft, Rear Setback = 15ft	Minimum Lot Frontage = 50ft, Side Setback = 10ft, Rear Setback = 20ft	R4 was created following the build-out analysis and the standards used utilized the Oct. 2018 R3 standards. The revised standards better reflect the intent and purpose of R4, which is to allow for development forms and patterns that further act as a transition between the larger lot/less dense residential neighborhoods (R1) to the smaller lots/more dense residential neighborhoods (N).
3.1.5.E.4	N/A	Add Multi-Building Assemblage (Sec. 3.5.4) as an allowed alternative lot configuration in R4	Increasing diverse housing opportunities, especially near public transportation/village centers

Article 3 - Residence District, Change Log

Section	Previous Recommendation	Proposed Recommendation	Goal, Problem Addressed, or Reasoning
3.1.6.C	Front Setback = 5ft (min.), Side Setback = 10ft, Rear Setback = 20ft	Front Setback = 0ft (min.), Side Setback = 7.5ft, Rear Setback = 15ft	The recommended changes to setback requirements within the N district more closely align with the goal of providing more housing opportunities closest to village centers and public transit in a form is appropriate for these transition areas between residential neighborhoods and village centers.
3.1.6.C - 3.1.6.D	See 3.1.2.C-3.1.2.D "Dimensional Standards" and "Contextual Front Setback"	See 3.1.2.C-3.1.2.D "Dimensional Standards" and "Contextual Front Setback"	See 3.1.2.C-3.1.2.D "Dimensional Standards" and "Contextual Front Setback"
3.2.2	Allow for a Special Permit to vary the dimensional standards of any Building Type	Remove the ability to ask for a Special Permit to vary the dimensional standards of any Building Type. Instead, use Building Components as a more predictable, yet still flexible, manner to go beyond the allowed Building Type dimensional standards	The data used to create the Building Type dimensional standards comes from analyzing Newton's existing building stock and architecture/building design best practice for residential development. The standards created help achieve City Council's objectives of promoting contextual development and smaller development sizes to achieve a more sustainable built pattern. In addition, the Planning Department recommends that Building Components are a simpler, more streamlined, mechanism to allow for development then the Special Permit process.

Article 3 - Residence District, Change Log

Section	Previous Recommendation	Proposed Recommendation	Goal, Problem Addressed, or Reasoning
3.2.3.B	(a) Set minimum and maximum building width and depth standards. (b) Allow for an increase to the maximum footprint by Special Permit of 600 sf	(a) Remove minimum and maximum building width and depth standards. (b) Remove allowance for an increase to the maximum footprint by Special Permit of 600 sf	(a&b) Simplify and streamline the permitting review process. The building widths and depths proposed are not based on existing conditions in Newton, or building best practices. Other standards in place, like lot coverage, setbacks, and frontage buildout achieve the desired result of having building relate to the street. (b) Building Components are proposed to offer the controlled flexibility necessary for existing homes to reasonable evolve as homeowners needs change, and for new homes to have more articulation and feel less "boxy".
3.2.3.C	Remove fenestration on the front elevation requirements	Put back fenestration on the front elevation requirements	Though building code does require certain amounts of fenestration along the building, zoning should have additional standards to contribute to Newton's goal of development that creates the desired look and feel of its residential neighborhoods. Fenestrations greatly contribute to this. The allowable range is large enough for appropriate flexibility.

Article 3 - Residence District, Change Log

Section	Previous Recommendation	Proposed Recommendation	Goal, Problem Addressed, or Reasoning
3.2.3.E.2	Allow a maximum of 1 Residential Unit within this House Type.	Allow a maximum of 2 Residential Unit within this House Type.	Increasing diverse housing opportunities, while also ensuring that new development appropriately relates to the existing neighborhood. The allowed building form remains the same, which is based on the existing building in Newton. This is recommended as an option, not a requirement. New development, or renovations, of this building type can have 1 residential unit.
3.2.3.E.3 (old)	Require outdoor amenity space 1/dwelling unit	Remove requirement of outdoor amenity space 1/dwelling unit	This regulation requirement of outdoor amenity space is appropriate for larger development types that allow for more units. For this House Type it is an example of overregulation.
3.2.3.E.E (new)	New item	Cap the amount of allowed Building Components that can increase Building Footprint beyond the allowable maximum to 25%	The cap of 25% allows enough flexibility for existing homes, and new construction, with large enough lots to add habitable space, but not so much that the resulting development does not contextually fit within its neighborhood. The Planning Department recommends 25% because this allows a development to become as large as most existing building in Newton of the same Building Type (i.e. contextual).
3.2.4.B	See 3.2.3.B "Building Dimensional Standards"	See 3.2.3.B "Building Dimensional Standards"	See 3.2.3.B "Building Dimensional Standards"
3.2.4.C	See 3.2.3.C "Fenestration"	See 3.2.3.C "Fenestration"	See 3.2.3.C "Fenestration"

Article 3 - Residence District, Change Log

Section	Previous Recommendation	Proposed Recommendation	Goal, Problem Addressed, or Reasoning
			See 3.2.3.E.2. It is common for existing House B residential buildings to have been converted into 2+ residential units, Newton Highland has many examples of this. There fore to promote the preservation of Newton's existing building stock and increase diverse housing opportunity, Staff recommend this Building Type be included in Multi-Unit Conversion.
3.2.4.E.2	See 3.2.3.E.2 "housing choice"	See 3.2.3.E.2 "housing choice", and allow option for this Building Type to utilize Multi-Unit-Conversion	
3.2.4.E.3 (old)	See 3.2.3.E.3 (old) "Outdoor Amenity Space"	See 3.2.3.E.3 (old) "Outdoor Amenity Space"	See 3.2.3.E.3 (old) "Outdoor Amenity Space"
3.2.4.E.3 (new)	See 3.2.3.E.3 (new) "Building Component Allowance"	See 3.2.3.E.3 (new) "Building Component Allowance"	See 3.2.3.E.3 (new) "Building Component Allowance"
3.2.5.B	See 3.2.3.B "Building Dimensional Standards"	See 3.2.3.B "Building Dimensional Standards"	See 3.2.3.B "Building Dimensional Standards"
3.2.5.C	See 3.2.3.C "Fenestration"	See 3.2.3.C "Fenestration"	See 3.2.3.C "Fenestration"
3.2.5.E.2	See 3.2.3.E.2 "housing choice"	See 3.2.3.E.2 "housing choice"	See 3.2.3.E.2 "housing choice"
3.2.5.E.3 (old)	See 3.2.3.E.3 (old) "Outdoor Amenity Space"	See 3.2.3.E.3 (old) "Outdoor Amenity Space"	See 3.2.3.E.3 (old) "Outdoor Amenity Space"
3.2.3.E.3 (new)	See 3.2.3.E.3 (new) "Building Component Allowance"	See 3.2.3.E.3 (new) "Building Component Allowance"	See 3.2.3.E.3 (new) "Building Component Allowance"
3.2.6.B	See 3.2.3.B "Building Dimensional Standards", and maximum footprint = 3,500 sf	See 3.2.3.B "Building Dimensional Standards, and maximum footprint = 2,300 sf (smaller footprint)	See 3.2.3.B. The original proposal of 3,500 was not based on existing single-story "ranch" style houses. 2,300 sf reflects the median footprint size of this house type in Newton. This will ensure that future development of this Building Type will be contextual since the standard is bases on existing conditions. The smaller footprint also promotes the City Council's goals on environmental sustainability by promoting smaller building sizes.

Zoning Redesign

Article 3 - Residence District, Change Log

Section	Previous Recommendation	Proposed Recommendation	Goal, Problem Addressed, or Reasoning
3.2.6.C	See 3.2.3.C "Fenestration"	See 3.2.3.C "Fenestration"	See 3.2.3.C "Fenestration"
3.2.6.E.2	See 3.2.4.E.2 "housing choice"	See 3.2.4.E.2 "housing choice"	See 3.2.4.E.2 "housing choice"
3.2.6.E.3 (old)	See 3.2.3.E.3 (old) "Outdoor Amenity Space"	See 3.2.3.E.3 (old) "Outdoor Amenity Space"	See 3.2.3.E.3 (old) "Outdoor Amenity Space"
3.2.6.E.3 (new)	See 3.2.3.E.3 (new) "Building Component Allowance"	See 3.2.3.E.3 (new) "Building Component Allowance"	See 3.2.3.E.3 (new) "Building Component Allowance"
3.2.7	Two-Unit Residence	Duplex	Building Type more accurately refers to form.
3.2.7.B	See 3.2.3.B "Building Dimensional Standards", and maximum footprint = 2,000 sf	See 3.2.3.B "Building Dimensional Standards", and maximum footprint = 1,800 sf (smaller footprint)	See 3.2.3.B. And the new maximum footprint more closely aligns with existing two-unit (Duplex) developments in Newton, and New England generally. It also, will promote smaller development, which will help to lower costs and help achieve certain goals around sustainability. Also, this differentiates between a Duplex and a Townhouse Section. A Townhouse Section is two-units (or more) side-by-side.
3.2.7.C	See 3.2.3.C "Fenestration"	See 3.2.3.C "Fenestration"	See 3.2.3.C "Fenestration"
3.2.7.E.2	State that a Two-Unit Residence must have 2 residential units	State that a Two-Unit Residence (now Duplex) must have 2 residential units, stacked one over the other	The requirement that a Duplex have the units stacked one over the other more closely aligns with the existing/historical built form of Duplex development in Newton, and New England generally.
3.2.7.E.3 (old)	See 3.2.3.E.3 (old) "Outdoor Amenity Space"	See 3.2.3.E.3 (old) "Outdoor Amenity Space"	See 3.2.3.E.3 (old) "Outdoor Amenity Space"
3.2.7.E.3 (new)	See 3.2.3.E.3 (new) "Building Component Allowance"	See 3.2.3.E.3 (new) "Building Component Allowance"	See 3.2.3.E.3 (new) "Building Component Allowance"
3.2.8	3-Unit Building	Triple Decker	Building Type more accurately refers to form.
3.2.8.B	See 3.2.3.B	See 3.2.3.B	See 3.2.3.B

Article 3 - Residence District, Change Log

Section	Previous Recommendation	Proposed Recommendation	Goal, Problem Addressed, or Reasoning
3.2.8.C	See 3.2.3.B, and maximum footprint proposed to be 1,600 sf	See 3.2.3.B, and maximum footprint proposed to be 1,800 sf	See 3.2.3.B. The slightly larger building footprint for the Triple Decker is recommended because it allows for the required two means of egress and staircases, while still allowing for the unit size to accommodate a 3 bedroom/2 bathroom apartment/condo. This footprint is derived from standard New England triple decker buildings since it is not a robust building form in Newton.
3.2.8.E.2	New item	Add language that states this building type must have 3 residential units and the units must be stacked one over the other.	Make clear that this building type must have 3 residential units. This addition is necessary after changing this from the originally proposed Apartment House building type from the Oct. 2018 draft.
3.2.8.E.3 (old)	See 3.2.3.E.3 (old) "Outdoor Amenity Space"	See 3.2.3.E.3 (old) "Outdoor Amenity Space"	See 3.2.3.E.3 (old) "Outdoor Amenity Space"
3.2.8.E.3 (new)	New item	Cap the amount of allowed Building Components that can increase Building Footprint beyond the allowable maximum to 10%	The cap of 10% allows enough flexibility for existing homes, and new construction, with large enough lots to add habitable space, but not so much that the resulting development overshadows existing development within the neighborhood. The Planning Department recommends 10% because this allows for controlled flexibility. Larger building types, with more units, have a lower percentage allowance because we want to encourage denser, smaller development, where these building types are allowed.
3.2.9.B	See 3.2.3.B "Building Dimensional Standards"	See 3.2.3.B "Building Dimensional Standards"	See 3.2.3.B "Building Dimensional Standards"

Article 3 - Residence District, Change Log

Section	Previous Recommendation	Proposed Recommendation	Goal, Problem Addressed, or Reasoning
3.2.9.C	See 3.2.3.C "Fenestration"	See 3.2.3.C "Fenestration"	See 3.2.3.C "Fenestration"
3.2.9.E.3	N/A	Add language that Townhouse Sections must have at least 2 sections within a series of townhouses	Clarifying language to ensure Townhouse Sections are only allowed in a series. This also corresponds to the change in definition for Duplex. A duplex is a single structure with two-units stacked on over the other. Two-units, side-by-side, is a series of Townhouse sections.
3.2.9.E.4	1 Townhouse Section must be oriented to the street	2 Townhouse Sections must be oriented to the street	Requiring at least 2 Townhouse Sections to orient to the street means that new development will better relate to the street and ensure the buildings do not face away from the public realm. This is meant to address one of the issues frequently seen under the current ordinance with Single-Family Attached.
3.2.9.E.5	See 3.2.8.E.3 (new) "Building Component Allowance"	See 3.2.8.E.3 (new) "Building Component Allowance"	See 3.2.8.E.3 (new) "Building Component Allowance"
3.2.10	4-8 Unit Building	Small Apartment House	Building Type more accurately refers to form.

Article 3 - Residence District, Change Log

Section	Previous Recommendation	Proposed Recommendation	Goal, Problem Addressed, or Reasoning
			See 3.2.3.B. The original proposal of 2,500 sf was not based on data of existing development in Newton. Since there are not many existing buildings that match this Building Type, the Planning Department recommends a footprint of 3,600 because it would allow for a form that is essentially two attached triple-decker buildings (mirrored). As discussed with the Triple Decker footprint, this would allow for the required egress and staircases and six sizeable units, or potentially eight slightly smaller units.
3.2.10.B	See 3.2.3.B, and maximum proposed footprint of 2,500 sf	See 3.2.3.B, and maximum proposed footprint of 3,600 sf	
3.2.10.C	See 3.2.3.C	See 3.2.3.C	See 3.2.3.C
3.2.10.E.2	Remove Residential Unit Factor (RU) calculation because it no longer applies to the revised building type.	Add language that states this building type must have between 4-8 residential units	Make clear that this building type must have 4-8 residential units. This addition is necessary after changing this from the originally proposed Small Apartment Building in the Oct. 2018 draft.
3.2.10.E.4	See 3.2.8.E.3 (new)	See 3.2.8.E.3 (new)	See 3.2.8.E.3 (new)
3.2.11.B	See 3.2.3.B	See 3.2.3.B	See 3.2.3.B
3.2.11.C	See 3.2.3.C	See 3.2.3.C	See 3.2.3.C

Article 3 - Residence District, Change Log

Section	Previous Recommendation	Proposed Recommendation	Goal, Problem Addressed, or Reasoning
3.2.11.E.3	Shop House upper stories must be residential use	Shop House upper stories must be residential use or office use	The Planning Department recommends this Building Type allow for office use on the upper floors because it is in line with these existing Building Types that exist in and near village centers. Given that this Building Type is only allowed in the N district, it makes sense to allow office uses that would be compatible with, and support these transition zones between residential neighborhoods and village centers. The offices uses allowed are much more limited then those in village centers.
3.2.11.E.6	See 3.2.8.E.3 (new)	See 3.2.8.E.3 (new)	See 3.2.8.E.3 (new)
3.2.12.C	See 3.2.3.C, and propose ground story fenestration to be 50% minimum	See 3.2.3.C, and propose ground story fenestration to be 30%	See 3.2.3.C. The Planning Department recommends a less restrictive number to allow for the appropriate amount of flexibility in potential ground floor uses, which can include a mixture of retail/office, and accessible residential units that may be burdened by the greater fenestration requirement.
3.2.13	N/A	Remove the Small Shop building type	Though this is a building form the currently exists in Newton, it is not a building form that help achieve the City's goals. A one-story retail space is not an efficient building form. Per the goals of increasing housing opportunity, and strengthening the local economy it would be a better outcome for these existing building forms to add on a second story above with residential or office.

Article 3 - Residence District, Change Log

Section	Previous Recommendation	Proposed Recommendation	Goal, Problem Addressed, or Reasoning
3.2.14	N/A	Remove the Civic Building building type	Since a Civic Building may be only occupied by Dover protected uses do not need a set building type because they have State Rules that supersede the local zoning ordinance.
3.3.1	New item	Add a table that clearly defines what building components are permitted, not permitted, and permitted by Special Permit for each building type	This table adds clarity and makes it more user friendly. In addition, not all building components are appropriate for all building types, which was not specified in the previous draft.
3.3.2	Original heading, "Architectural Components on the Front Elevation"	Proposed heading, "Architectural Components"	Previous title implies that these building component regulations only apply along the front elevation of the building. The new title more generally applies to building components anywhere on the building. This is important especially for denser areas Newton, where regulating these components in side yards (for example) is necessary as well.
3.3.2.C	Front Porch	Porch	Clearer language
3.3.2.C.3.a	Stairs may encroach...	Stairs or ramp may encroach...	Explicitly allow for greater levels of accessibility to better serve Newton residents
3.3.2.D	Projecting Front Entry	Projecting Entry	Clearer language
3.3.2.C.D.a	Uncovered stairs...	Uncovered stairs or ramp may encroach...	Explicitly allow for greater levels of accessibility to better serve Newton residents
3.3.2.E	Turret building component	Propose to remove the Turret building component and incorporate into the Bay building component	Minimize any language that implies style.

Article 3 - Residence District, Change Log

Section	Previous Recommendation	Proposed Recommendation	Goal, Problem Addressed, or Reasoning
3.3.2.F	New item	Add a Side Wing building component	Allow for controlled flexibility, and an easier path, for existing buildings to evolve and change as homeowner needs change. Encourage articulated development where the building mass is broken up so it does not feel overly large or "boxy".
3.3.2.G	New item	Add a Rear Addition building component	See 3.3.2.F "building components"
3.3.3.A.3.a	N/A	Add minimum slope to reflect the revised, more simplified, definition of Roof Type to 0 stories, 0.5 stories, and 1 story.	Previous text (Article 2) defined Roof Types by styles that implied design. The new recommended definition is a simplified diagram that draws from the current zoning definition of half-stories.
3.3.3.B.3.a	See 3.3.3.A.3.a "accessibility"	See 3.3.3.A.3.a "accessibility"	See 3.3.3.A.3.a "accessibility"
3.4.1.A	Contextual Front Setback set as the rule for new construction	Remove Contextual Front Setback regulation	Current Code only has a minimum front setback. The proposed code has a minimum and maximum, which sets a contextual range based on the existing conditions in Newton. This range is a simpler, and more flexible, regulation then requiring new development to exactly match the neighboring structures.
3.4.2	See May 19, 2020 ZAP memo on Garage Design Standards	See latest draft, Sec. 3.4.2 - Garage Design Standards	All of Sec. 3.4.2 was updated and presented to ZAP on May 19, 2020. The changes reflected in this latest draft focus on formatting, clarification, and other minor issues to fully achieve the goals set out by the City Council for garages.

Article 3 - Residence District, Change Log

Section	Previous Recommendation	Proposed Recommendation	Goal, Problem Addressed, or Reasoning
3.5.2.A	Only building types that allow Multi-Unit Conversion are House A and Civic Building	Allow Multi-Unit Conversion in House (A, B, C, D) and Civic Building	Throughout Newton there are many examples of building types, beyond just House A, that have already been converted into multiple units. Allowing these additional building types to develop as Multi-Unit Conversion encourages the maintained used of existing housing (i.e. reduce tear downs) and allows for the increasing of diverse housing opportunities throughout Newton.
3.5.2.B	New item	Explicitly state that the only alterations to the exterior of a building utilizing Multi-Unit Conversion are limited to building components and those necessary to comply with health, building, and fire codes	Limit the ability to manipulate the Multi-Unit Conversion regulation and ensure the existing building is maintained to the greatest extent possible.
3.5.2.D	All Multi-Unit Conversion development requires a special permit	Propose a threshold for some Multi-Unit Conversion projects (6-units or less) to be by right, while requiring larger project (7-units or more) to be by special permit	Simplify and streamline the permitting review process. The zoning should allow and facilitate what Newton wants (increasing diverse housing opportunities, encouraging development that respects and responds to the neighborhood)
3.5.3.B.1	New item	Add Courtyard Cluster standards for R4	Increase diverse housing opportunity in a way that is scaled to fit within the neighborhoods these development occur in. As a new district, the previous draft did not set standards for R4.
3.5.3.B.2	See 3.5.3.B.1 "Courtyard Cluster in R4"	See 3.5.3.B.1 "Courtyard Cluster in R4"	See 3.5.3.B.1 "Courtyard Cluster in R4"
3.6.2	New item	Add section to Use Table for R4	As a new district, the previous draft did not set uses for R4.

Article 3 - Residence District, Change Log

Section	Previous Recommendation	Proposed Recommendation	Goal, Problem Addressed, or Reasoning
3.7.1.A.5	Allow for on-street parking to count towards minimum parking requirements for all uses within the Residential Districts	Allow for on-street parking to count towards minimum parking requirements only for non-residential uses within the Residence Districts	Allowing on-street parking to count for residential uses does not make sense with the current winter overnight parking rules.
3.7.1.E	See May 19, 2020 ZAP memo on Garage Design Standards	See latest draft, Sec. 3.7.1.E - Driveway Access	All of Sec. 3.7.1.E was updated and presented to ZAP on May 19, 2020. The changes reflected in this latest draft focus on formatting, clarification, and other minor issues to fully achieve the goals set out by the City Council for driveways.

Guide to Residence Zoning in Newton

3 Step Process

1. Lot
2. Building type
3. Building components

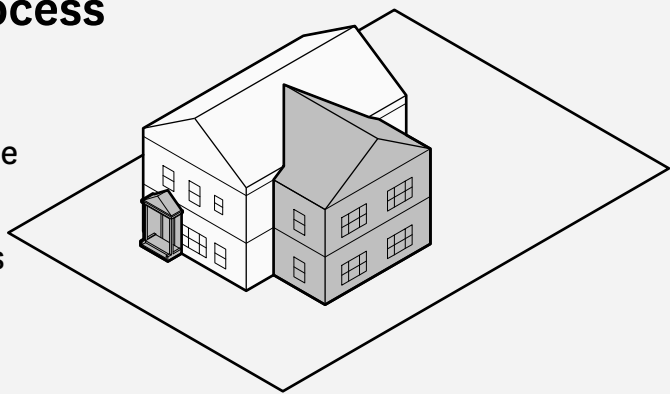

1 What district is the lot in?

Each district has rules for how far buildings must be set back from lot lines, and for maximum lot coverage. For additional rules see Section 3.1.

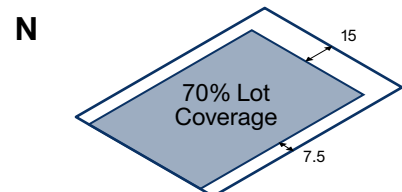
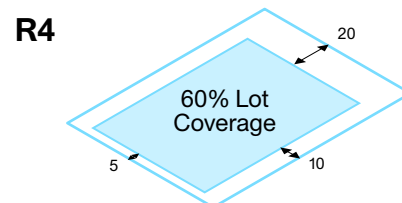
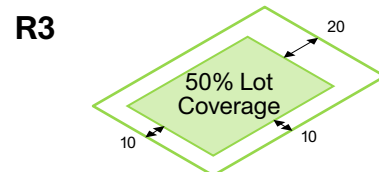
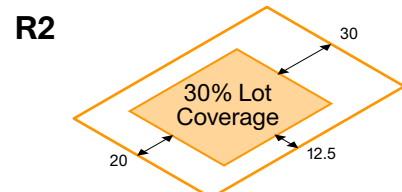
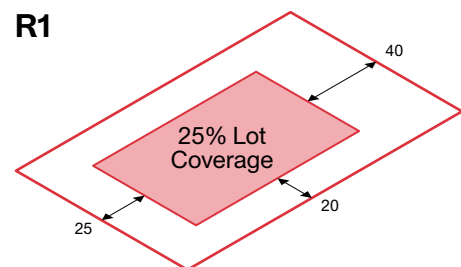

2A What building types are allowed in the district?

Check the colored dots below each building type to see the districts in which it is allowed. Dots with a dashed line around them indicate that the building type is only allowed by special permit. Building types define the form of buildings allowed. Here they are drawn to their maximum footprint and height. For more information, see Section 3.2.

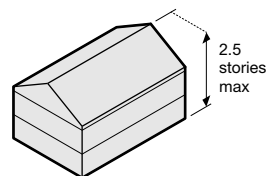

House A
max footprint 2400 sf

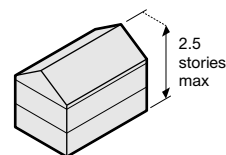

House B
max footprint 1400 sf

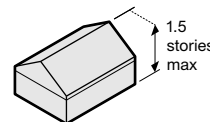

House C
max footprint 1200 sf

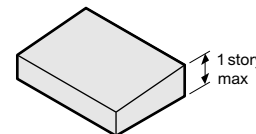

House D
max footprint 2300 sf

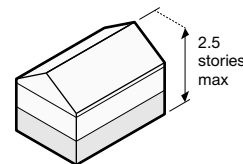

Duplex
max footprint 1800 sf

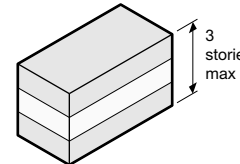

Triple Decker
max footprint 1800 sf

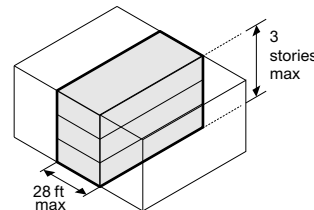

Townhouse Section
max footprint 1500 sf

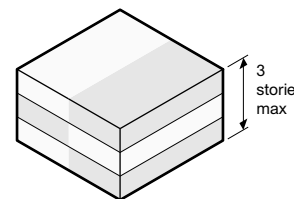

Small Apartment House
max footprint 3600 sf

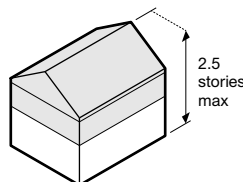

Shop House
max footprint 2000 sf

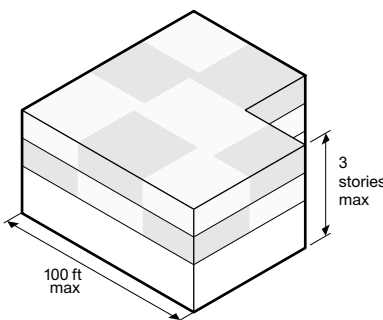

Small Multi-Use Building
max footprint 12000 sf



2B Are alternate lot or building configurations allowed?

Rear Lots



Multi-Unit Conversion**



Courtyard Cluster



Multi-Building Assemblage*



* Depending on the scale of the project, Multi-Unit Conversions and Multi-Building Assemblages, may be permitted by-right.

** Multi-Unit Conversions are only allowed within certain Building Types. See Section 3.5.2.

3 Which building components are allowed with my building type?

Extra habitable space can be added to buildings through the use of building components. Building components can increase the total building footprint beyond the maximum. For House A to Duplex, up to 25% of the maximum footprint can be added. The percentage drops to 10% for the Triple Decker to Shop House. Certain building components do not count toward the building footprint. See Section 3.3.2 and 3.3.3 for details on each building component, including which building type it can be added to, how far it can encroach into setbacks, and its allowable dimensions.

Count toward Building Footprint. Special Permit required for Triple Deckers to Small Multi-Use Buildings

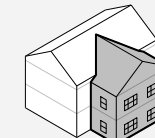

Side Wing

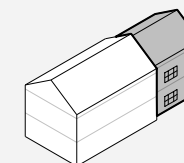

Rear Addition

Do not count toward Building Footprint.

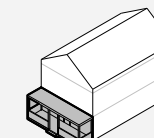

Porch

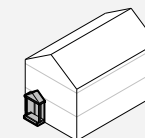

Projecting Entry

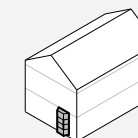

Bay

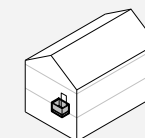

Balcony

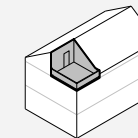

Roof Deck

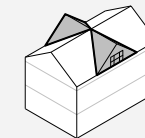

Cross Gable

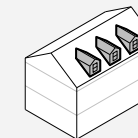

Dormer